

Design for Assembly and Manufacturing

- Sophisticated products involves a large number of individual components and subassemblies.
- 70 to 80 percent of the cost of manufacturing a product is determined during the design phase
- A rational design for easy and low-cost assembly is the selection of the most appropriate method for assembling these product.
- So, a design Engineer should be concerned with the ease and cost of assembly.
- Thus, the concept of design for assembly (DFA) emerged.

TYPES AND CHARACTERISTICS OF ASSEMBLY METHODS

Manual Assembly

- In manual assembly, the operations are carried out manually with or without the aid of simple, general-purpose tools like screwdrivers and pliers.
- Individual components are transferred to the workbench either manually or by employing mechanical equipment such as parts feeds or transfer lines and then are manually assembled.
- This assembly method is characterized by its flexibility and adaptability.
- The assembly cost per product is nearly constant
- Independent of the production volume.

TYPES AND CHARACTERISTICS OF ASSEMBLY METHODS

Automatic Assembly

- Mainly referred to as *fixed automation or the Detroit type*.
- Either synchronous indexing machines and automatic feeders or non-synchronous machines where parts are handled by a free-transfer device are used.
- Machines are dedicated for the production/assembly of a product.
- These systems lack any flexibility to accommodate tangible changes in the design of the product.
- Requires a large-scale capital investment, as well as considerable time and engineering work before actual production can be started.

Types and characteristics of assembly methods

Automatic Assembly Using Robots / Robotic Assembly:

- Production volume is higher than that of a manual assembly system but lower than that of an automatic assembly system (Fixed automation).

Common forms of Robotic Assembly:

1. One-arm robot operating at a single workstation that includes parts feeders, magazines, etc.
2. Two robotic arms operating at a single workstation
 - A programmable controller (PLC) is used to simultaneously control and synchronize the motions of the two arms.
 - Referred as a robotic assembly cell and similar to FMS cell.
3. Multi-station robotic assembly system
 - Capable of performing several assembly operations simultaneously.
 - Can perform different assembly operations at each station.
 - High flexibility and adaptability to design changes.

Comparison of Assembly Methods

- Manual assembly requires the least capital investment followed by the two simplest forms of robotic assembly.
- Multi-station robotic assembly system compares to Automatic system with special-purpose machines requires more capital investment for a large production volume but less capital investment for a moderate production volume.
- Assembly cost per product is constant for manual assembly

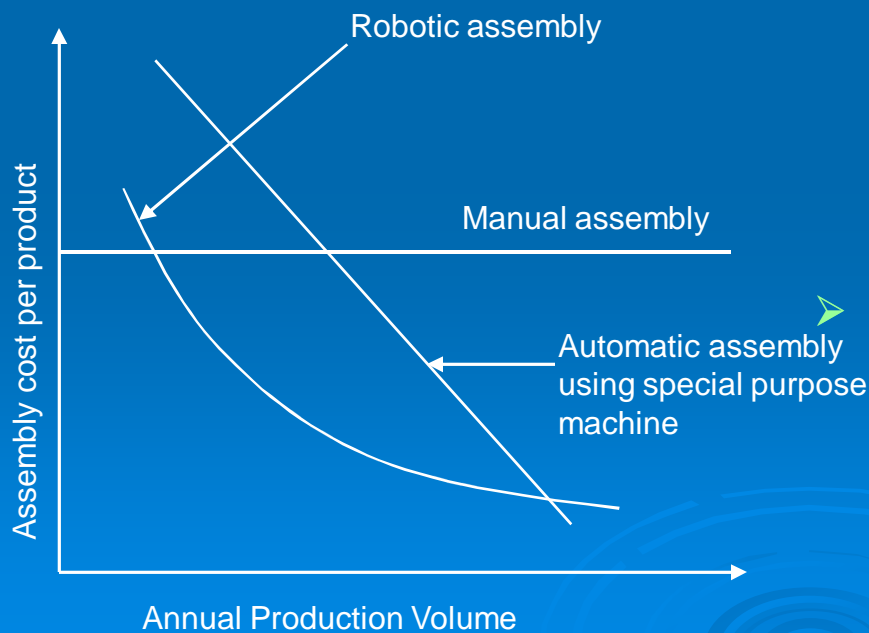

- Assembly cost per product is decreases linearly with increasing production volume for automatic assembly using special-purpose machines.

- In the case of robotic assembly, the assembly cost per product decreases with increasing production volume, but becomes less economical after exceeding the annual production volume at a certain point.

SELECTION OF ASSEMBLY METHOD

Factors affecting selection of an assembly method:

- Cost of assembly
- Annual production volume (or production rate),
- Number of individual components to be assembled in a product
- Number of different versions of a product / s
- Availability of labor (with cost consideration)
- Payback period
- These factors are interactive
- Impossible to have a single mathematical relationship between these factors.

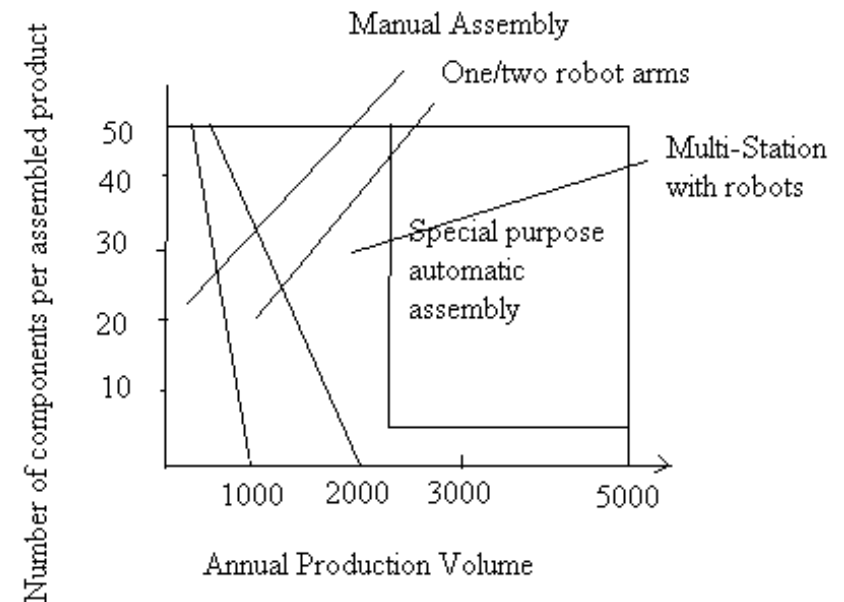

PRODUCT DESIGN FOR MANUAL ASSEMBLY

To design products for manual assembly we need to reduce both the assembly time and the skills required of assembly workers.

Guidelines for product design for manual assembly:

- Eliminate the need for any decision making by the assembly worker, including his or her having to make any final adjustments.
- Ensure accessibility and visibility.
- Eliminate the need for assembly tools or special gages by designing the individual components to be self-aligning and self-locating. Figure: it is far easier and takes less time to insert the pin with the chamfer.
- Minimize the types of parts by adopting the concept of standardization as a design philosophy.
- Expand the use of multifunction and multipurpose components.

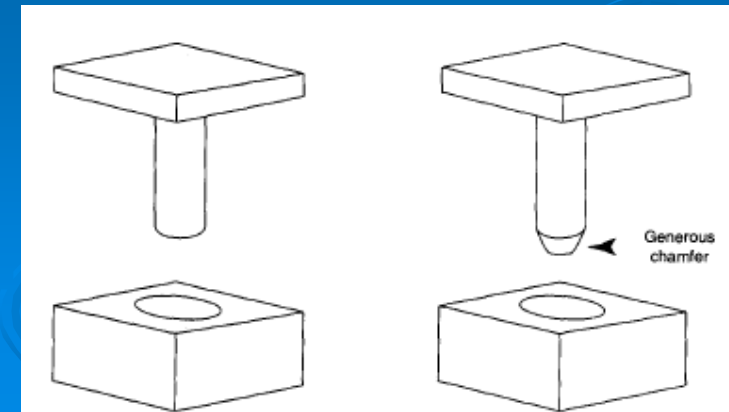

DESIGN FOR MANUAL ASSEMBLY continue...

- Minimize the number of individual parts in an assembly by eliminating excess parts and, whenever possible, integrating two or more parts together, as handling lesser parts are much easier.
- The criteria for reducing the parts count per assembly, established by G. Boothroyd and P Dewhurst involve negative answers to the following questions :
 - Does the part move relative to all other parts already assembled?
 - Must the part be of a different material or be isolated from other parts already assembled?
 - Must the part be separate from all other parts already assembled because otherwise necessary assembly or disassembly of other parts would be impossible?
- Avoid or minimize reorienting the parts during assembly. Try to make all motions simple by, for example, eliminating multi-motion insertions.
- Design parts having maximum symmetry in order to facilitate easy orientation and handling during assembly.

PRODUCT DESIGN FOR AUTOMATIC ASSEMBLY

Parts are required to be: uniform; high quality; have tighter geometric tolerances, to eliminate any downtime of the assembly system due to parts mismatch or manufacturing defects.

Important factors involves orientation, handling, and feeding of parts to the assembly machine. *Rules for automatic assembly are:*

- Reduce the number of different components in an assembly by using the three questions listed previously. Figure LHS
- Use self-aligning and self-locating features like chamfers, guidepins, dimples, and certain types of screws, in parts to facilitate the process of their assembly. Figure RHS.

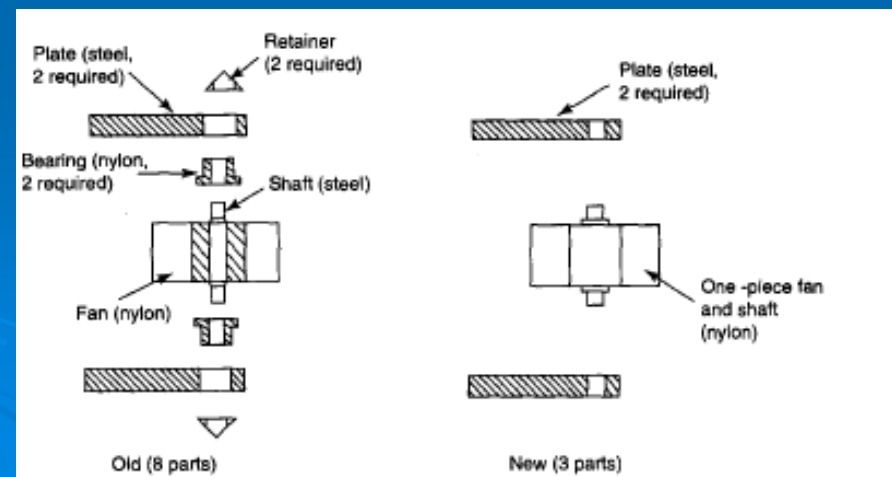
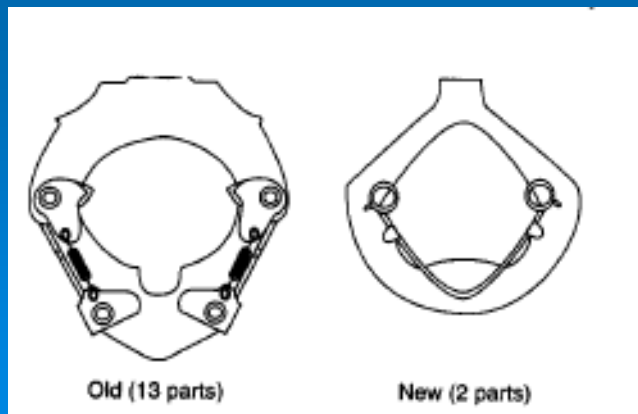

Design for Assembly

DESIGN FOR AUTOMATIC ASSEMBLY continue...

- Avoid, if possible, fastening by screws as it is expensive and time-consuming.
- Thus, recommended to design parts that will snap together or be joined together by a press fit. **(May lead to problems while disassembling the product for maintenance.)**
- If screws must be used, then unify their types and head shapes. Figure.
- Make the largest and most rigid part of the assembly as a base or fixture where other parts are stack-assembled vertically in order to take advantage of gravity. This will eliminate the need for employing an assembly fixture.
- Seek the use of standard components and/or materials, i.e. a high percentage of standard parts in any new design. Group technology can be adopted to achieve this goal.

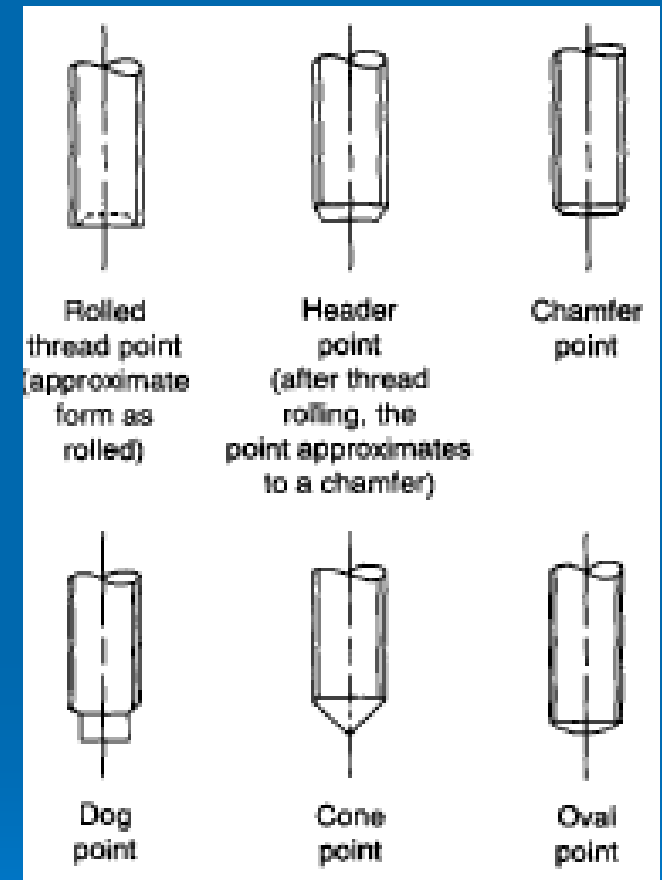

PRODUCT DESIGN FOR AUTOMATIC ASSEMBLY

continue...

- Avoid the possibility of parts tangling, nesting, or shingling during feeding. Figure.
- Avoid flexible, fragile, and abrasive parts and ensure that the parts have sufficient strength and rigidity to withstand the forces exerted on them during feeding and assembly.
- Avoid reorienting assemblies because each reorientation may require a separate station or a machine, both of which cause an appreciable increase in cost.

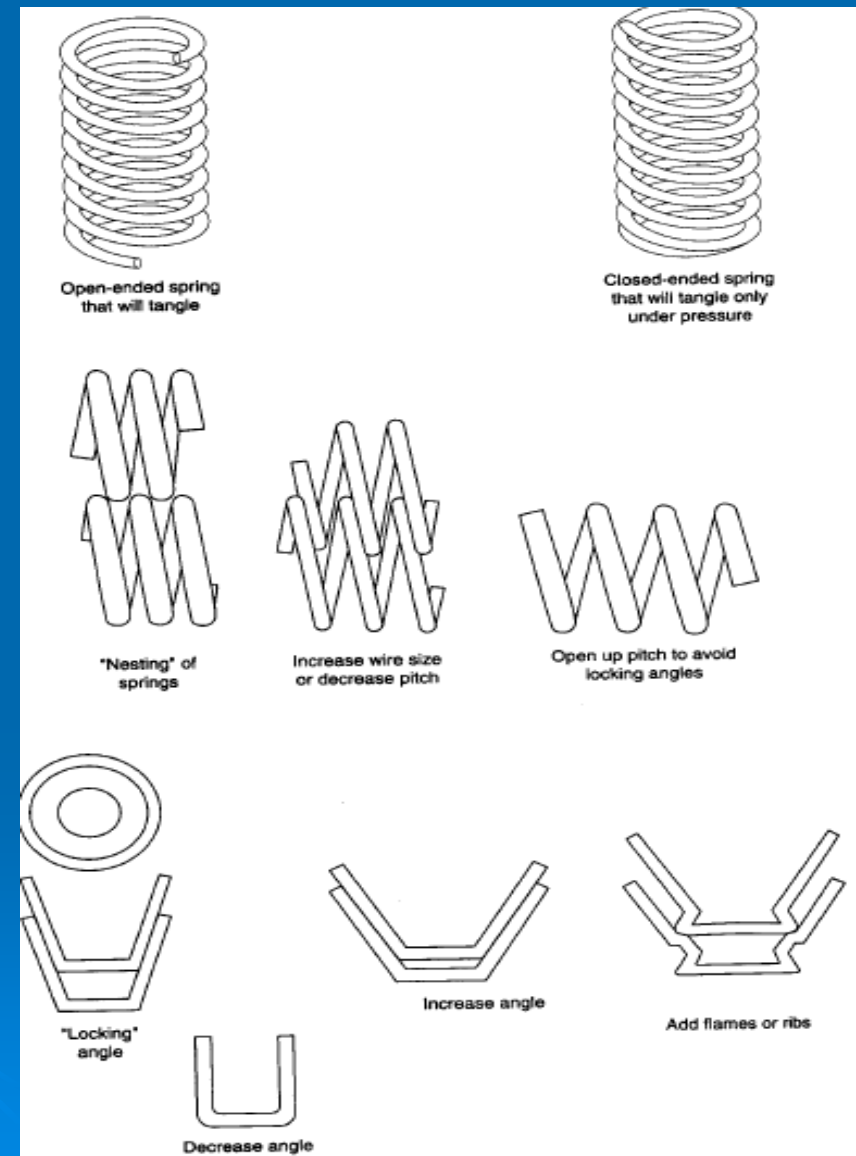







PRODUCT DESIGN FOR AUTOMATIC ASSEMBLY

continue...

➤ Design parts to ease automation by presenting or admitting the parts to the assembly machine in the right orientation after the minimum possible time in the feeder.

- The process in the feeder consists of rejecting parts resting in any position but the one desired.
- Figure shows the effect of the possible number of orientations on the efficiency of feeding.
- According to W. V. Tipping, two types of parts can easily be oriented:
 - Parts symmetrical in shape (e.g., a sphere or cube)
 - Parts with clear asymmetry (either in shape or weight).

Number of Orientations	Types of Parts	Required Number of Parts/Hour (out of the feeder)	Minimum Required Rate of Feeding Parts/Hour (into the feeder)
1	 Sphere  Symmetrical cube  Symmetrical flat washer	600	600
2	 Parts that naturally fall in one of two possible positions  Tapered washer	600	1200
4	 Parts having four natural positions	600	2400

PRODUCT DESIGN FOR AUTOMATIC ASSEMBLY

continue...

- Figure shows some small changes in the design of parts that result in full symmetry.
- It is easy to achieve symmetry with sheet metal and injection-molded parts because the manufacturing cost of adding a feature is relatively low.
- If it is too difficult or too expensive to achieve symmetry, nonfunctional features must then be added to make identification and grasping easier as shown in Figure.

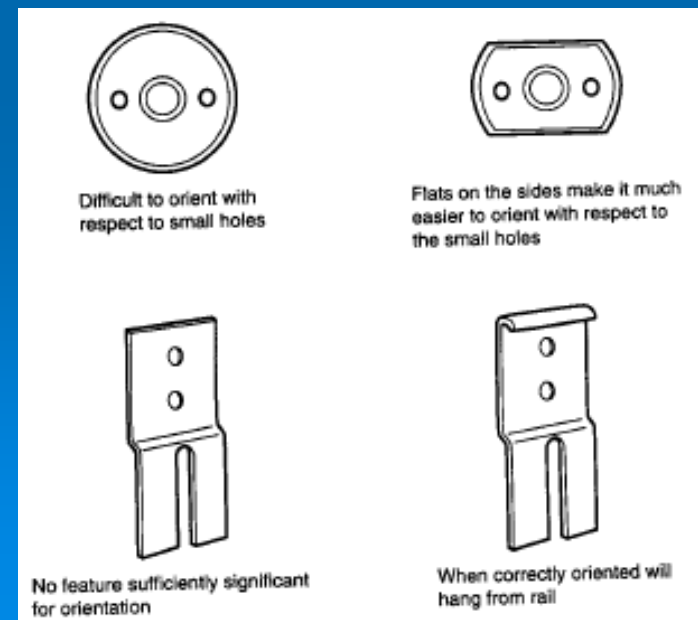
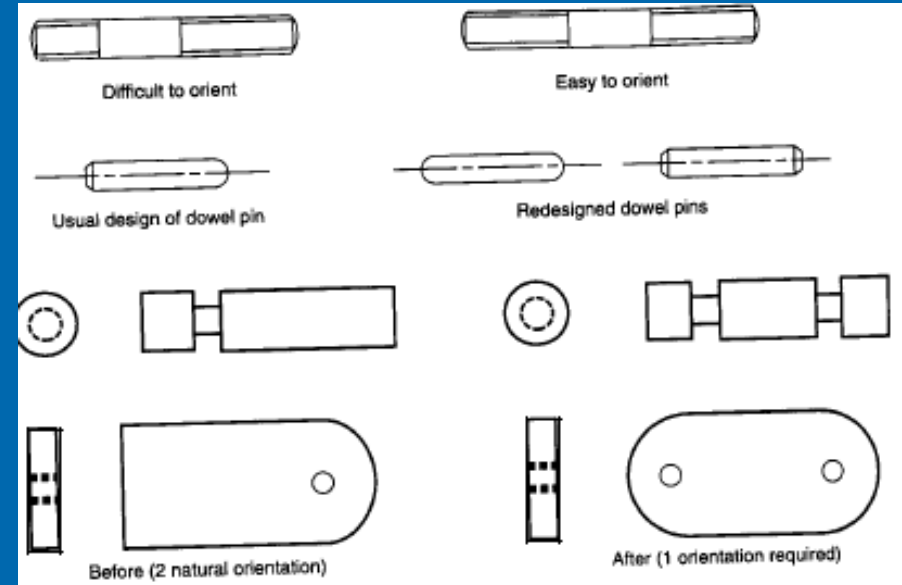

PRODUCT DESIGN FOR ROBOTIC ASSEMBLY

- The product design rules for robotic assembly are basically the same as those for manual and/or automatic assembly.
- Two very important and crucial considerations that have to be taken into account when designing components for robotic assembly:
 1. Design a component so that it can be grasped, oriented, and inserted by that robot's end effector. Failure to do so will result in the need for an additional robot and, consequently, higher assembly cost.
 2. Design parts so that they can be presented to the robot's arm in an orientation appropriate for grasping. Also, eliminate the need for reorienting assemblies (or subassemblies) during the assembly operation.

METHODS FOR EVALUATING AND IMPROVING PRODUCT DFA

- Methods are based on measuring the ease or difficulty with which parts can be handled and assembled together into a given product.
- An analytical procedure is followed where the problems associated with the components design are detected and quantitatively assessed.
- Most commonly used methods:
 - The Boothroyd-Dewhurst DFA Method
 - The Hitachi Assembly Evaluation Method
 - The Lucas DFA Method
 - The Fujitsu Productivity Evaluation System

The Boothroyd-Dewhurst DFA Method

- Developed in the late 1970s by Professor Geoffrey Boothroyd, at the University of Massachusetts, Amherst in cooperation with Salford University of England.
- The analysis cannot be employed to create a design from nothing but rather is used to evaluate and refine an existing design.
- First, the appropriate assembly method is selected by means of charts.
- Then, the analytical procedure corresponding to the assembly method selected is used (i.e., there is a separate, though similar, procedure for each of the assembly methods).
- Figure shows the stages of the Boothroyd-Dewhurst DFA method.

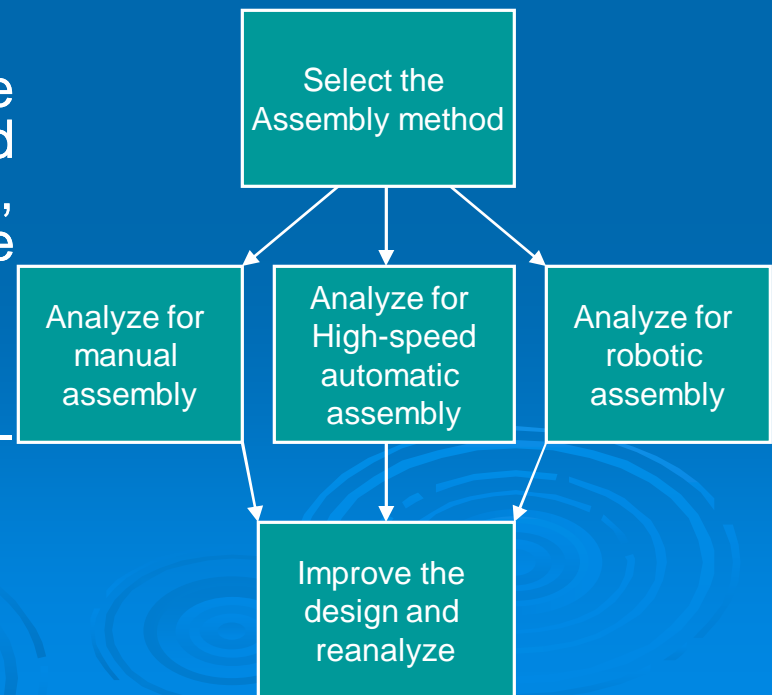

The Boothroyd-Dewhurst DFA Method continue...

- The first step is to determine the assembly sequence.
- The assembly time for each component part is then obtained by adding the handling time of that part to its insertion time.
- Once the components and the assembly time for each are known, total assembly time and assembly cost for the existing design is evaluated.
- The next step is aimed at reducing the parts count by eliminating or combining some parts. (as per the 3 questions described before). Thus finding “theoretically needed” parts.
- A design efficiency index is used to evaluate the improvement in design in a quantitative manner, given by:
$$\text{Design Efficiency} = (3 * N_m) / \text{calculated total assembly time}$$
where N_m is the theoretical minimum number of parts.
Assumption: total ideal assembly time 3 seconds.
- Design is improved by reviewing the worksheet and eliminating components that have relatively high handling and insertion times.
- This process is repeated until an optimal design is obtained.

The Hitachi Assembly Evaluation Method (AEM)

- Originally, employed to refine the designs of tape recorder mechanisms in order to develop an automatic assembly system for producing those subassemblies.
- The method does not explicitly distinguish between manual and automatic assembly, this difference is accounted for implicitly within the structured analysis.
- The Hitachi AEM approach is based on assessing the assemblability of a design based on two indices:
 1. An assemblability evaluation score (E) is used to assess design quality or difficulty of assembly operations.
 - The procedure to compute E is based on considering the simple downward motion for inserting a part as the "ideal reference."
 - For complicated operations, penalty scores that depend upon the complexity and nature of each operation are assigned.

Hitachi Assembly Evaluation Method continue...



➤ The Hitachi method uses symbols to represent operations, and there are about 20 of them covering operations. Ex: shown in figure.

➤ After completing a worksheet penalty score for each part is manipulated to give the assemblability evaluation score for that part.

➤ E values for all parts are then combined to produce an assemblability evaluation score for the whole assembly.

2. An estimated assembly cost ratio (K) is an indication of the assembly cost improvements.

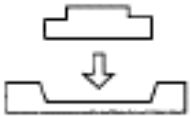
- K is the ratio between the assembly cost of the new (modified) design divided by the assembly cost of the initial and/or standard design.
- The method of estimating the time (and cost) of an operation involves breaking it into its elemental components and allocating time for each elemental motion based on compiled practical observations.
- Any saving in the assembly cost can be achieved by reducing the parts count in a product and/or simplifying the assembly operations.

Elemental operation	AEM symbol	Penalty score
	Downward movement	↓
	Soldering	S
		20

Lucas DFA Method

- Unlike the previous two methods, the Lucas DFA evaluation is not based on monetary costs, but on three indices that give a relative measure of assembling difficulty.
- The goal of reducing the parts count and the analysis of the insertion operations are shared with the previous two methods.
- Analysis is carried out in three sequential stages as shown in Assembly-sequence flowchart diagram:
 - Functional
 - Feeding (or handling)
 - Fitting analyses.

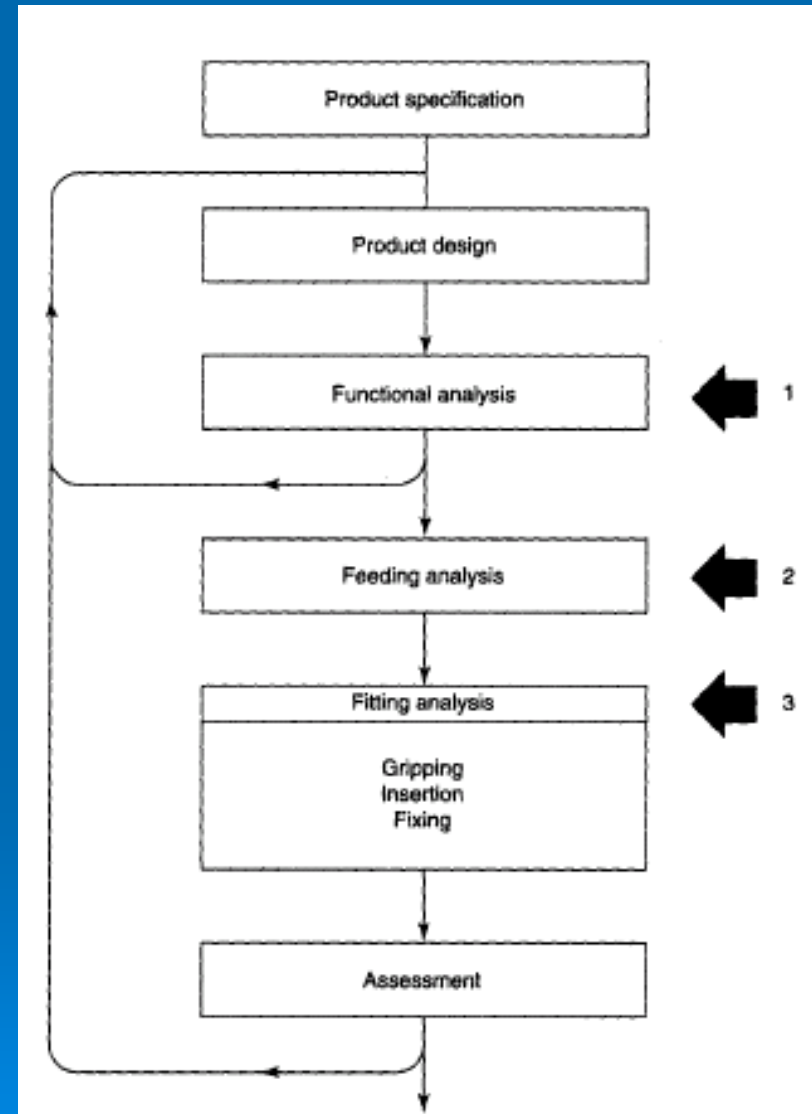

Lucas DFA Method continue...

Functional analysis:

- Components are divided into two groups.
 - Components that perform a primary function (essential components) or "A" parts.
 - Nonessential, or "B," components that perform only secondary functions like fastening and locating.
- Design efficiency is given by:
Design Efficiency = $100 * A / (A+B)$
- If the design efficiency is low, it is improved by eliminating most of the nonessential parts.
- Initial stage target is to achieve a design efficiency of 60 percent.

Feeding analysis:

- Concerned with the problems associated with handling components (or subassemblies) until they are admitted to the assembly system.
- Feeding /handling index is calculated based on size, weight, handling difficulties, and orientation of a part.
- Feeding /handling ratio can be calculated as:
Feeding/handling ratio = (Feeding/handling index) / Number of essential components
- An ideal value for this ratio is 2.5.

Lucas DFA Method continue...

Fitting analysis .

- The fitting analysis is divided into a number of subsystems including gripping, insertion, and fixing analyses.
- An index is given to each part based on its fixturing requirements, resistance to insertion, and whether or not there will be restricted vision during assembly.
- High individual values and/or a high total value of these indices means costly fitting operations.
- The fitting index is manipulated to yield the fitting ratio as:
fitting ratio = fitting index / number of essential components
- For acceptable design fitting ratio should be 2.5.

Feeding /handling and fitting ratios are used as "measures of performance" to indicate the effectiveness of the design quality with respect to assembly

DISADVANTAGE: Does not considers the manufacturing cost while making design changes, which can lead to a costly part.

The Fujitsu Productivity Evaluation System

- Unlike other DFA methods it is not a refinement procedure after completion of the detailed design. Rather it can be described as:
 - *A software package which can be used as a tool to aid in obtaining a detailed design that is easy to manufacture and assemble with cost effectiveness.*
- Limited to bench-type manual assembly of relatively small parts.
- Consists of four subsystems as shown in figure, based upon making full use of an expert system involving practical manufacturing and design data and rules of thumb gathered from experience.
- The software addresses a problem by carrying out a rough evaluation that can be followed by detailed evaluations made concurrently with the product development process.

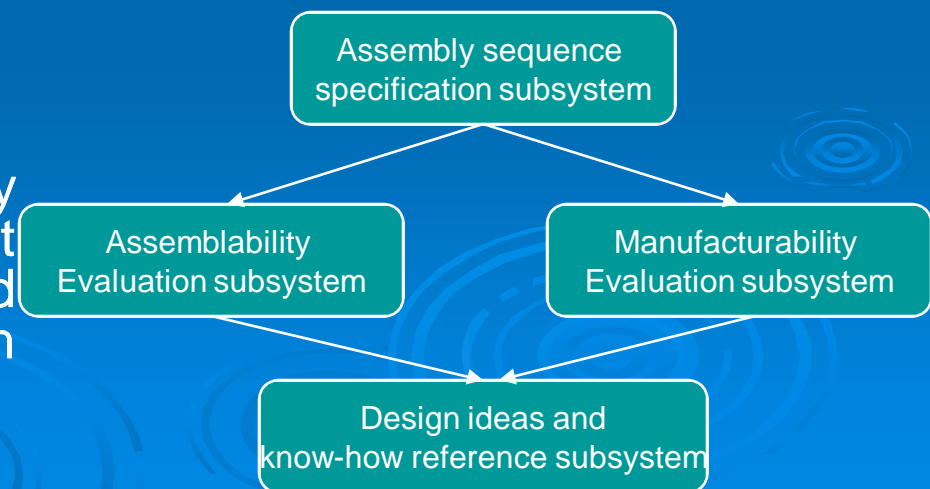

Design for Assembly

The Fujitsu PES continue...

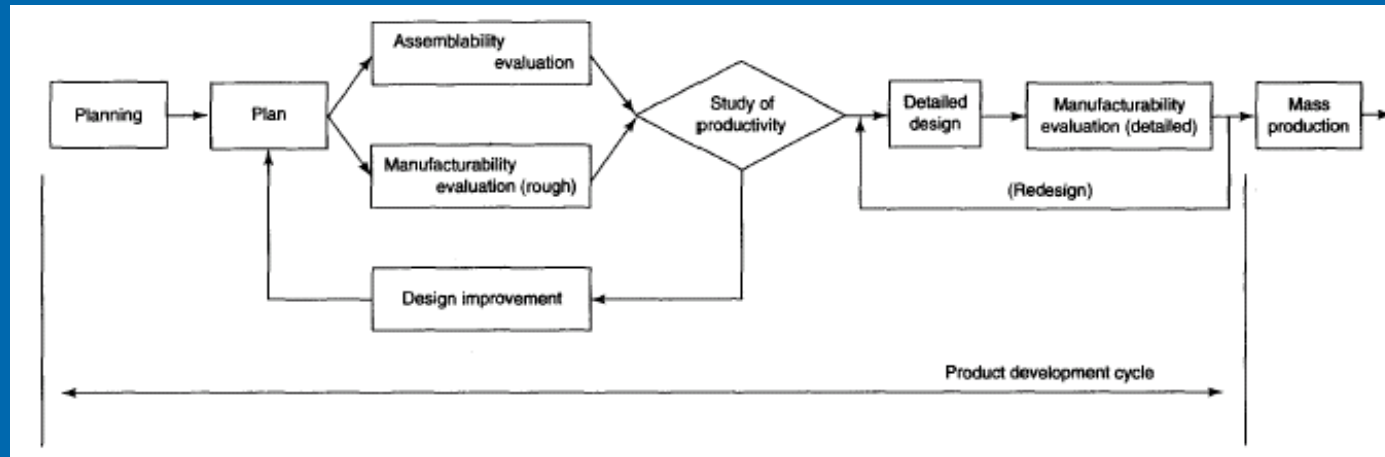

- Figure indicates the procedure for applying the productivity evaluation system throughout the product development cycle.

Assembly sequence specification subsystem:

- Designer selects parts similar to those envisioned to be used in the product and then specifies their assembly sequence.
- The system promptly retrieves previously stored values for assemblability and manufacturability that can be used by the evaluation subsystem to obtain assembly time and cost.

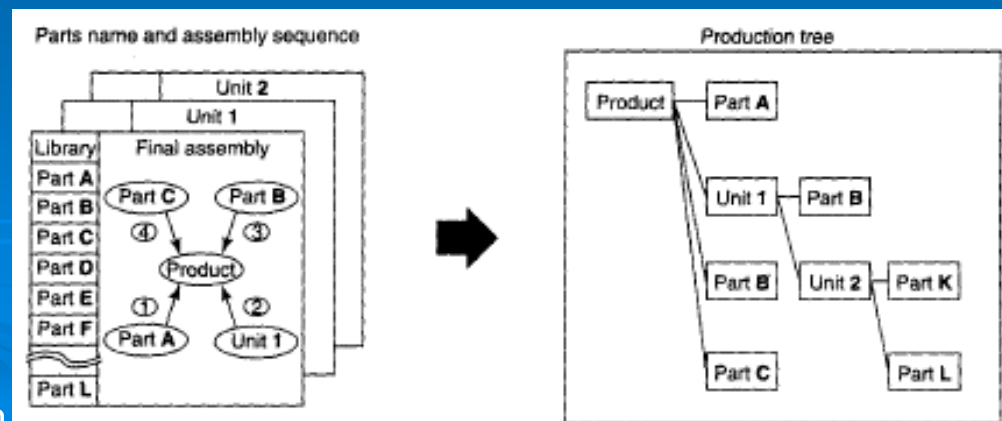

The Fujitsu PES continue...

Assemblability evaluation subsystem:

- Estimates assembly time and evaluate the ease of assembly, based upon a library of subassemblies and their number of essential parts that are stored by functional module.

Ex: Printing module includes dot printing (10 essential parts).

- Analysis addresses the handling and insertion of parts, specifies the target number of essential parts, and identifies high-cost processes and parts.
- Figure shows operation of this, and types of input and output data.



The Fujitsu PES continue...

Assemblability evaluation subsystem continue...

- System breaks down the assembly time of each part into handling time, insertion time, and so on, and displays it as a bar chart. See Figure (a).

- System also shows the assemblability evaluation score for the whole product as well as for assembly and adjustment operations. See Figure (b).

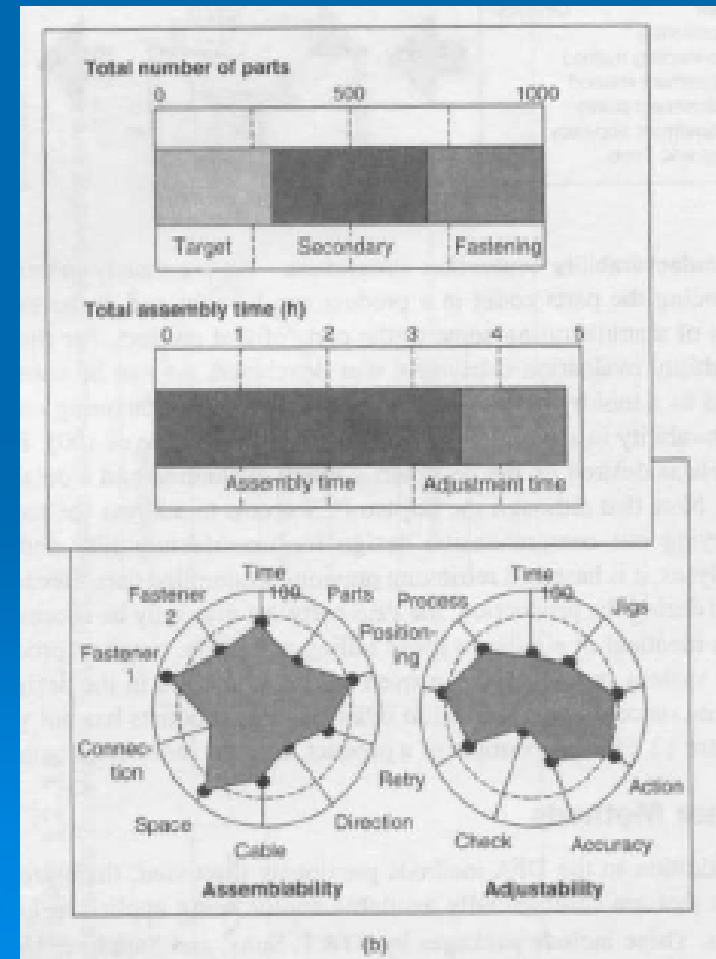
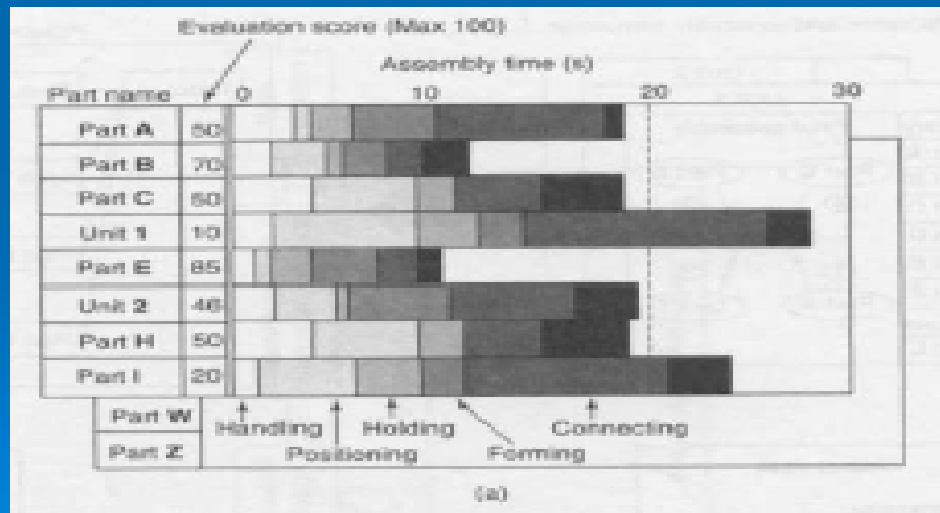

The Fujitsu PES continue...

Manufacturability evaluation subsystem:

- Used as a tool by the designer to estimate the manufacturing cost and evaluate manufacturability in a quantitative manner. See Figure.
- Can be done at two levels : rough evaluation or/and a detailed one.

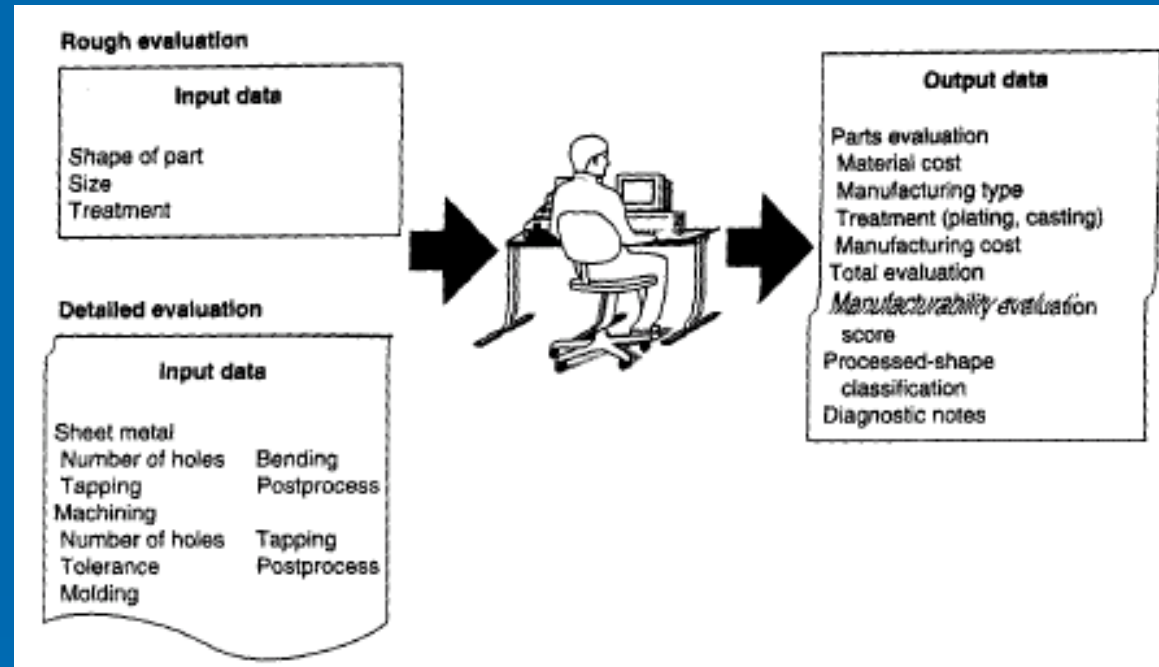

DISADVANTAGE:

Based on retrieving previously compiled data which are gathered during production. So, may only be successful for products identical or similar to those within the range of products of that company.

Design for Automation

- Crucial steps to improve Automation
 - Concurrent Design
 - Early Design of Assembly
 - Simultaneous design for Manufacturing
 - Design for Quality or Design for Six Sigma
- A good Automation is not a cure for poor design

Future of Automation

- More advanced knowledge of the effect of design in your product
- Virtual Prototyping
- Multi-purpose robots capable of carrying out several manufacturing activities
- Metal based Rapid Prototyping
- Highly Custom made products
 - Capability to 'intelligently configure' products that can be manufactured quickly
- ???