

DATA PROCESSING AND ELECTRONIC OFFICE AREAS

Design Criteria	17.1	Direct-Cooled Computer Equipment	17.5
Cooling Loads	17.2	Air-Conditioning Components	17.5
Air-Conditioning Systems	17.2	Instrumentation	17.6
Supply Air Distribution	17.3	Fire Protection	17.6
Return Air	17.5	Energy Conservation and Heat Recovery	17.6

DATA processing and electronic office areas contain computers, electronic equipment, and peripherals. Computer equipment has expanded beyond the traditional computer room to become an integral part of the entire office environment.

Computers and electronic equipment generate heat and gaseous contaminants, and usually contains components vulnerable to temperature and humidity variations, dust and other air impurities, and static electricity. Exposure to conditions deviating from prescribed limits can cause improper operation or complete shutdown of equipment and may substantially reduce equipment useful life expectancy (Weschler and Shields 1991). Losing equipment function or data can cause significant, sometimes irreparable damage.

Ancillary spaces for computer-related activities or for storing computer components and materials may require environmental conditions comparable to those where computers are housed, although tolerances may be wider and the degree of criticality is usually much lower. Other ancillary areas housing auxiliary equipment such as engine generators, motor generators, uninterruptible power supplies (UPSs), and transformers have less stringent air-conditioning and ventilating requirements than computer areas, but continuing satisfactory operation of this equipment is vital to proper functioning of the computer system.

DESIGN CRITERIA

Computer Rooms

Data processing spaces that house mainframe computers, computer personnel, and associated equipment require air conditioning to maintain proper environmental conditions for both the equipment and personnel. Computer room environments should be maintained within established limits and not be subjected to rapid changes.

Environmental requirements of computer equipment vary, depending on the manufacturer and type of equipment. [Table 1](#) lists conditions recommended for most computer rooms. Most manufacturers recommend that the computer equipment draw conditioned air from the room. Some equipment may require direct cooling using conditioned air, chilled water, or refrigerant. Criteria for air-cooled computers may differ from those cooled by room air in that this air must remove computer equipment heat adequately and prevent moisture condensation within the equipment ([Table 2](#)).

Because large amounts of heat are released, designs should minimize energy use for cooling, humidification, and dehumidification.

Room Environmental Requirements

The distribution of air in the room and/or the response of controls may not match the nonuniform heat distribution of the equipment. Modern computer equipment is controlled to minimize energy input, which results in a much wider variation in power consumption and heat release than for older equipment.

The preparation of this chapter is assigned to TC 9.2, Industrial Air Conditioning.

Table 1 Typical Computer Room Design Conditions

Condition	Recommended Level
Temperature control range ^a	72°F ± 2°F
Relative humidity control range ^a	50% ± 5%
Filtration quality ^b	45%, min. 30%

^aThese conditions are typical of those recommended by most computer manufacturers.
^bFrom ASHRAE *Standard* 52.1 dust-spot efficiency test.

Table 2 Design Conditions for Air Supply Direct to Computer Equipment

Condition	Recommended Level
Temperature	As required for heat dissipation
Relative humidity ^a	Maximum 65%
Filtration quality ^b	45% minimum

^aSome manufacturers permit up to 80% rh.
^bPer dust spot efficiency test in ASHRAE *Standard* 52.1.

High relative humidity may cause improper paper feeding, corrosion, and, in extreme cases, condensation on cold surfaces of direct-cooled equipment. Low relative humidity, with other factors, may result in static discharge, which can destroy equipment or adversely affect operation. Volatile organic compounds can plate onto critical surfaces like disk drives, causing the head to crash, and onto printed circuit boards where dust and static electricity can induce stray currents in very-low-voltage applications.

Before it is introduced into the computer room, outside air should be treated and preconditioned to remove dust, salts, and corrosive gases. Dust can adversely affect the operation of data processing equipment, so high-quality filtration and proper filter maintenance are essential. Corrosive gases can quickly destroy the thin metal films and conductors used in printed circuit boards, and corrosion can cause high resistance at terminal connection points.

Computer room air conditioning must provide adequate outside air to (1) dilute internally generated contaminants and (2) maintain the room under positive pressure relative to surrounding spaces. The need for positive pressure to keep contaminants out of the room is usually a controlling design criterion. An outside air quantity of 6 to 8 air changes per day usually satisfies contaminant dilution requirements (Weschler and Shields 1991). Although most computer rooms have few occupants, ventilation for human occupancy should be provided in accordance with ASHRAE *Standard* 62. Where outside air is diluted with recirculated air from the computer room or adjacent areas, higher ventilation rates are required.

Air-conditioning equipment for computer spaces should be served by electrically isolated power sources to prevent electrical noise from adversely affecting computer operation and reliability. Equipment located in computer spaces should be independently supported and isolated to prevent vibration transmission to the computers. Computer manufacturers should be consulted regarding equipment sound tolerance and specific requirements for vibration isolation.

Temperature, humidity, and filtration requirements are within the comfort range for room occupants, but drafts and cold surfaces must be minimized in occupied areas. Some manufacturers have established criteria for allowable rates of environmental change to prevent shock to the computer equipment. These can usually be satisfied by controls with ranges of $\pm 1^\circ\text{F}$ and $\pm 5\%$ rh. Manufacturer requirements should be reviewed and fulfilled to ensure that the system will function properly during normal operation and during start-up and shutdown. Computer equipment usually tolerates a somewhat wider range of environmental conditions when idle, but it may be desirable to operate the air conditioning to keep the room within those limits and minimize thermal shock to the equipment.

Because technology is continually changing, computer equipment in a given space will be changed and/or rearranged during the life of an air-conditioning system. The system must be sufficiently flexible to permit rearrangement of components and expansion without requiring rebuilding. Typically, it should be possible to modify the system without extensive air-conditioning shutdowns. In critical applications, it should be possible to modify the system without shutdown.

Isolation of Computer Spaces

Computer equipment spaces are usually isolated for security and environmental control. To maintain proper relative humidity in computer rooms in otherwise unhumidified spaces, vapor retarders sufficient to restrain moisture migration during the maximum expected vapor pressure differences between the computer room and surrounding areas should be installed around the entire envelope. Cable and pipe entrances should be sealed and caulked with a vapor-retarding material. Door jambs should fit tightly. In exterior walls in colder climates, windows should be double- or triple-glazed and door seals are required. An air lock is recommended for a computer room door that opens directly to the outside.

Ancillary Spaces

Storage spaces for products such as paper and tapes generally require conditions similar to those in the computer room.

Electrical power supply and conditioning equipment can tolerate more variation in temperature and humidity than computer equipment. Equipment in this category includes motor generators,

UPSs, batteries, voltage regulators, and transformers. Ventilation to remove heat from the equipment is normally sufficient. Manufacturer data should be checked to determine the amount of heat release and design conditions for satisfactory operation.

Battery rooms for UPSs require ventilation to remove hydrogen and to control space temperature. The optimum space temperature is 77°F . Temperatures maintained higher or lower reduce the ability of batteries to hold a charge. Hydrogen accumulation should be no greater than 2% of the battery room volume. If battery room design information is unavailable, use 4 air changes per hour for the exhaust to prevent pockets of concentration, particularly at the ceiling.

Engine generators used for primary or emergency power require large amounts of ventilation when running. This equipment is easier to start if a low ambient temperature is avoided.

COOLING LOADS

The major heat source in a computer room is the equipment. This heat tends to be highly concentrated, nonuniformly distributed, and increasingly variable. Computer components that generate large quantities of heat are normally constructed with internal fans and passages to convey cooling air, usually drawn from the space, through the machine. Heat gain from lights should be determined from the lighting plan; occupancy loads should be considered as light work. Heat gains through the structure depend on the location and construction of the room. Transmission heat gain to the space should be carefully evaluated and provided for in the design. Vapor retarder analyses should be performed where humidity-controlled spaces contain windows on outside walls.

Information on computer equipment heat release should be obtained from the manufacturers. In general, air-conditioning systems should be sized without a reduction for diversity, unless the computer manufacturer or experience with a similar installation recommends it.

Heat generated in computer rooms is almost entirely sensible. For this reason and because of the low room design temperatures, air supply quantity per unit of cooling load will be greater than for most comfort applications. Figure 1 shows that choosing room design at 72°F , 45% rh can reduce air supply quantity by approximately 15% compared to a slightly more humid room design of 72°F , 50% rh. A sensible heat ratio between 0.9 and 1.0 is common for computer room applications.

AIR-CONDITIONING SYSTEMS

It may be desirable for air-handling systems for data processing areas to be independent of other systems in the building, although cross-connection with other systems may be desirable for backup. Redundant air-handling equipment is frequently used, normally with automatic operation. Air-handling facilities should provide ventilation air, air filtration, cooling and dehumidification, humidification, and heating. Refrigeration systems should be independent of other systems and may be required year-round, depending on design.

Computer rooms can be conditioned with a wide variety of systems, including packaged precision air-conditioning units and central station air-handling systems. Air-handling and refrigeration equipment may be located either inside or outside computer rooms.

Precision Air-Conditioning Units

Precision air-conditioning units should be specifically designed for computer room applications and built to and tested in accordance with the requirements of ASHRAE *Standard 127*. Precision units are available with chilled-water or multiple-refrigerant compressors with separate refrigeration circuits, air filters, humidifiers, reheat, and integrated control systems with remote monitoring panels and interfaces. These units may also be equipped with dry coolers and propylene glycol precooling coils to permit water-side economizer operation where weather conditions make this strategy economical.

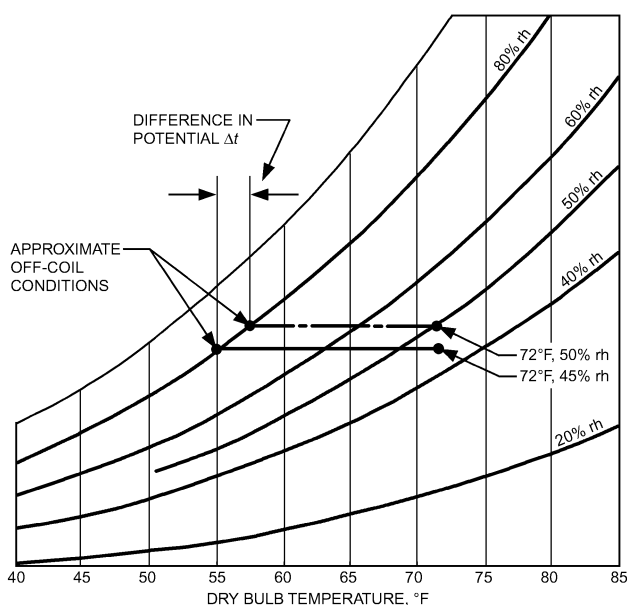

Fig. 1 Potential Effect of Room Design Conditions on Design Supply Air Quantity

Self-contained air conditioners are usually located within the computer room but may also be remotely located and ducted to the conditioned space. If they are remote, their temperature and humidity controls should be in the conditioned space. Locating the air conditioner close to the load improves system flexibility to accommodate the changing load patterns common in computer rooms. Remote units may not have security protection beyond standard building maintenance. Where security is an issue, special attention should be paid to protecting the refrigerant condensing equipment for remote units.

In systems using precision air-conditioning units, it may be advantageous to introduce outside air through a dedicated system serving all data processing areas. Redundancy can be achieved with multiple units so that the loss of one or more units has less effect on overall system performance. Expansion of an existing data processing facility is often easier with precision air-conditioning units than with central station systems.

A set point of 72°F with constant-volume precision air-conditioning units generally permits equipment to remain at an acceptable temperature within the established range for satisfactory operation. This low control set-point temperature provides a cushion for short-term peak load temperature rise without adversely affecting computer operation. Compared to constant-volume units, variable-volume equipment can be sized to provide excess capacity but operates at discharge temperatures appropriate for optimum humidity control, minimize operational fan horsepower requirements, provide superior control over space temperature, and reduce the need for reheat.

When chilled-water precision air-conditioning units are used, the reliability of the remote refrigeration system must be considered. This system generally must be capable of operating 24 h per day, and provisions must be made for a year-round supply of chilled water. Chilled-water precision air-conditioning units do not contain refrigeration equipment and generally require less servicing, can be more efficient, provide smaller room temperature variations, and more readily support heat recovery strategies than direct-expansion equipment.

Central Station Air-Handling Units

Central station supply systems should be designed to accommodate expanding loads in the computer areas. They have a larger capacity than precision air-conditioning units and offer significantly greater opportunities for energy conservation. Systems that use direct evaporative humidification with mechanical cooling and variable-volume control allow the use of outside air for free cooling without a humidification energy penalty (see [Chapter 51, Evaporative Cooling Applications](#)). Waste heat from computer equipment can be used to provide the heat of vaporization.

By using discharge air temperature as a method of dew-point control, variable-volume ventilation from air-handling equipment, using evaporative equipment with a saturation effectiveness of 90% or higher, can provide effective humidity control without humidity sensing or active control. [Figure 2](#) illustrates a central station unit configuration that provides air at a constant temperature and dew point. As this cool air is provided at rates to maintain design space temperature, space relative humidity becomes a direct function of space temperature, eliminating the need for expensive and unreliable humidity controls. Efficiency is increased by the evaporative process, which can use waste heat from the computers to provide the necessary heat of vaporization for humidification.

Because data processing areas have an extremely high sensible heat ratio, variable-volume becomes a viable strategy, further reducing energy use. The evaporative process eliminates the need for refrigeration at temperatures below the supply air temperature of the system and reduces the need for refrigeration for significant periods of time when outside air conditions permit an evaporative cooling benefit. Stable, less-than-saturated air conditions can be achieved

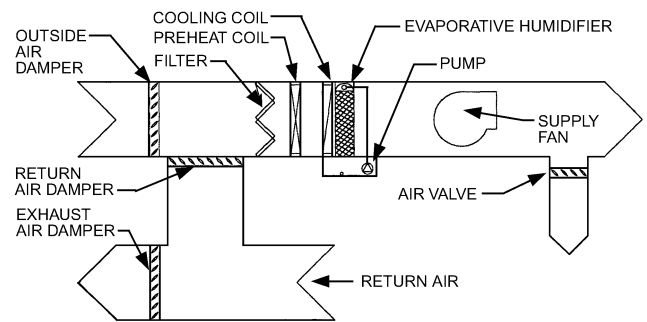

Fig. 2 Constant Temperature/Dew-Point Air-Handling Unit

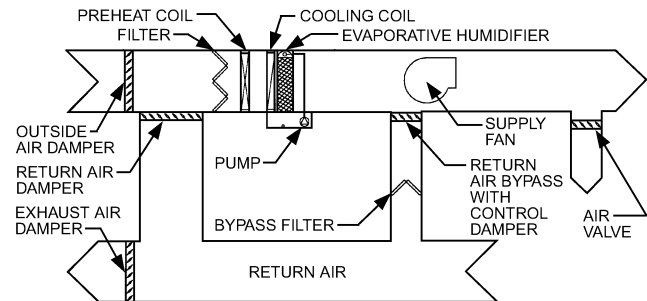

Fig. 3 Air-Handling Unit with Return Air Bypass

by bypassing system return air around the evaporative process to warm and dehumidify the supply air (see [Figure 3](#)).

Central station air-handling equipment should be arranged for convenient servicing and maintenance. Flexibility and redundancy can be achieved by using variable-volume distribution, oversizing, cross-connecting multiple systems, or providing standby equipment. No floor space in the computer room is required, and sources of water and refrigeration may be eliminated from the computer room. Virtually all servicing and maintenance operations are performed in areas devoted specifically to air-conditioning equipment. System security issues, however, must be addressed.

Central systems serving computer rooms may serve other building functions if designed to provide continuous, year-round operation and to meet the cooling and humidification requirements. Central systems are superior to precision air-conditioning units for the electronic office area where overall environmental requirements may approach those of the computer room. Care should be taken to exercise redundant equipment frequently to prevent conditions that enhance the growth of mold and mildew in filters, insulated unit enclosures, and outside air pathways where spores and food sources for microbial growth may accumulate.

SUPPLY AIR DISTRIBUTION

To minimize room temperature gradients, supply air distribution should closely match load distribution. Distribution systems should be sufficiently flexible to accommodate changes in the location and magnitude of the heat gains with minimum change in the basic distribution system. Distribution system materials should ensure a clean air supply. Duct or plenum material that may erode must be avoided. Access for cleaning is desirable.

Zoning

Computer rooms should be adequately zoned to maintain design temperatures and to minimize temperature variations from load fluctuations. Individual control for each major zone is desirable. The controlling thermostat must be located where it will sense the average

conditions in the area it serves. In larger areas, temperature variations within a single room may occur, and subzoning may be desirable.

Underfloor Plenum Supply

To facilitate interconnection of equipment components by electric cables, data processing equipment is usually set above a false floor, which affords a flat walking surface over the space where the connecting cables are installed. This space can be used as an air distribution channel, either as a plenum or, less often, to accommodate ducts.

Figure 4 shows a typical setup with underfloor plenum air supply. Air is distributed to the room through perforated panels or registers set or built into floor panels around the room, especially near computer equipment with high heat release. Airflow can be controlled by the size, location, and quantity of floor registers and perforated floor panels. These systems have the flexibility to accommodate relocation of computer equipment and future additional heat loads. All air should flow through openings in the underfloor cavity unless direct flow to a computer unit is desired. The potential adverse effect of direct air supply on computer equipment (i.e., condensation within the machine) is serious enough to discourage its use unless the manufacturer requires it. Most openings between the underfloor space and equipment usually exist to accommodate cables; collars are available that fit the cable and seal the opening.

Floor panels can be similar in appearance to, and interchangeable with, conventional computer room floor panels. The free area of floor panels may vary significantly between manufacturers. Because they are completely flush with the floor, perforated floor panels are suitable for installation in normal traffic aisles. With moderate airflows, panels located fairly close to equipment can produce a high degree of mixing near the point of discharge and will better prevent drafts and injection of unmixed conditioned air into computers than floor registers. Figure 5 shows typical floor panel air performance.

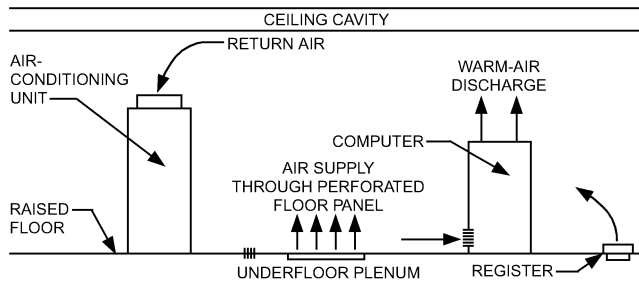

Fig. 4 Typical Underfloor Distribution

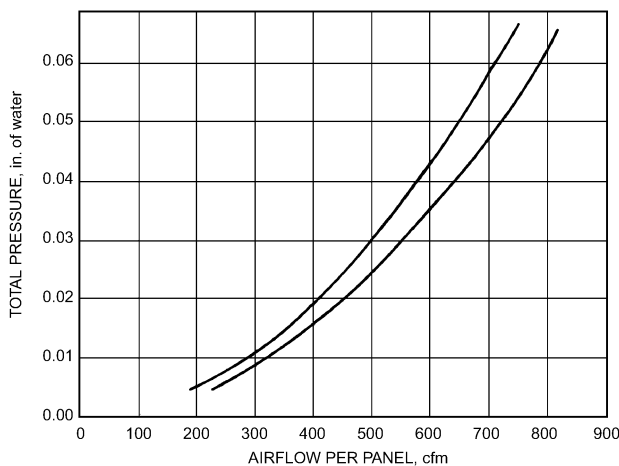

Fig. 5 Floor Panel Air Performance

Floor-mounted registers allow volume adjustment and are capable of longer throws and better directional control than perforated floor outlets. Floor registers, however, should be located outside traffic areas. Some are not flush-mounted, and almost all tend to be draftier for nearby personnel than perforated floor panels with lower induction ratios.

Sufficient clearance to permit airflow must exist beneath a raised plenum floor: 12 in. of clearance is desirable, and 10 in. is the usual minimum. In applications where cabling is extensive and/or air quantities are especially high, additional floor clearance may be required. Supply air connections into an underfloor cavity should be designed to minimize air turbulence. Where possible, supply to the cavity should be central to the area served, and abrupt changes in direction should be avoided. Piping, cable, and conduit should not be allowed to interfere with supply airflow.

Where multiple zones are served from an underfloor plenum, dividing baffles may be omitted because air will follow the path of least resistance. Dividing baffles required to meet fire codes can impede the modification of computer systems with cabling interconnections between zones because any cable change may entail penetration of a zone baffle.

Plenums should be airtight, thoroughly cleaned, and smoothly finished to prevent entraining foreign materials in the airstream. The use and method of construction of plenums may be restricted by local codes or fire underwriter regulations. Surfaces in underfloor plenums (e.g., water, chilled-water, brine, or refrigerant piping) may require insulation and a vapor retarder if surface temperatures are low enough to cause condensation. If this is the case, water detectors should be installed to protect computers and underfloor wiring.

Ceiling and Ceiling Plenum Supply

Overhead supply through ceiling diffusers, shown in Figure 6, may be suitable for computer rooms. Ceiling and ceiling plenum supply systems can satisfy equipment and personnel comfort requirements, but they are generally not as flexible as underfloor plenum supply systems. This arrangement is compatible with both central station and packaged unitary equipment.

Distribution of air can be regulated by selective placement of acoustical pads on the perforated panels of a metal panel ceiling or by placement of active perforated sections in a lay-in acoustical tile plenum ceiling. Where precise distribution is essential, active ceiling diffusers or air supply zones may be equipped with air valves. Ceiling plenums, if properly constructed and cleaned, are more likely to remain clean than underfloor plenums.

Ceiling plenums must be deep enough to permit airflow without turbulence; the required depth depends on air quantities. Best conditions may be achieved by using distribution ductwork, with air discharged into the space through air valves or adjustable outlets above the ceiling. Overhead supply systems should be limited to applications where air supply concentrations are low or the need for flexibility is small. Where loads are high, aspirating diffusers may

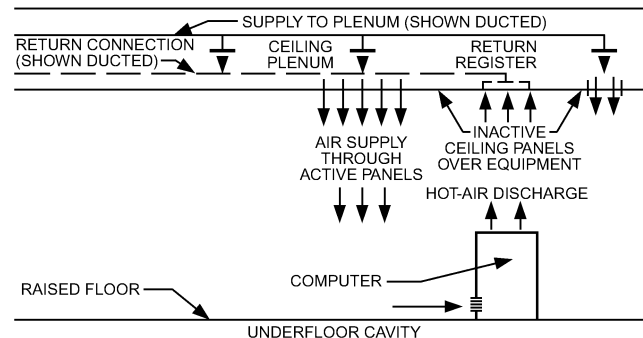

Fig. 6 Typical Ceiling Plenum Distribution

cause drafts, especially if the ceilings are low. It can be difficult to relocate rigidly ducted outlets in a facility that must remain in continuous operation.

RETURN AIR

Using ceiling plenum returns is common and effective. Inlets should be located above equipment with high heat dissipation to take advantage of the thermal plume created above the equipment. Ceiling plenum returns can capture part of the heat from computers and lights directly in the return airstream, allowing a reduced air circulation rate. Ceiling plenum returns enhance the flexibility of the space to support future modifications of the computer installation.

DIRECT-COOLED COMPUTER EQUIPMENT

Most cooling in direct-cooled equipment is still accomplished with space air. Some computer equipment requires direct cooling to maintain the equipment environment within the limits established by the manufacturer. Heat released to the space from this equipment is usually equal to or greater than that for similar air-cooled computer systems. Generally, a closed system circulates distilled water or refrigerant through passages in the computer to cool it. Manufacturers normally supply the cooling system as part of the computer equipment.

Chilled water may be provided by either a small chiller matched in capacity to the computer equipment or a branch of the chilled-water system serving the air-handling units. Design and installation of chilled-water or refrigerant piping and selection of the operating temperatures should minimize the potential for leaks and condensation, especially in the computer room, while satisfying the requirements of the systems served. Chilled-water systems for water-cooled computer equipment must be designed to (1) provide water at a temperature within the manufacturer's tolerances and (2) be capable of operating year-round, 24 h per day.

AIR-CONDITIONING COMPONENTS

Controls

A well-planned control system must coordinate the performance of the temperature and humidity equipment. Controls for central station air-handling equipment may be included in a project-specific control system. Space temperature and humidity sensors should be carefully located to sample room conditions accurately.

Where multiple packaged units are provided, integrating control systems and regular calibration of controls is necessary to prevent individual units from working against each other. Errors in control system calibration, differences in unit set points, and sensor drift can cause multiple-unit installations to simultaneously heat and cool, and/or humidify and dehumidify, wasting a significant amount of energy.

Refrigeration

Refrigeration systems should be designed to match the anticipated cooling load, should be capable of expansion, and may be required to provide year-round, continuous operation. A separate refrigeration facility for the data processing area may be desirable where system requirements differ from those provided for other building and process systems and/or where emergency power requirements preclude combined systems. The system must provide the reliability and redundancy to match the facility's needs. System operation, servicing, and maintenance should not interfere with facility operation. If required, the refrigeration system should be operable with emergency power. Fulfilling these requirements may require multiple units or cross-connections with other reliable systems. If the installation is especially critical, it may be necessary to install up to 100% standby capacity to meet the minimum requirements in the event of equipment failure.

Humidification

Many types of humidifiers may be used to serve data processing areas, including steam-generating (remote or local), pan (with immersion elements or infrared lamps), and evaporative types (wetted pad and ultrasonic). Ultrasonic devices should use deionized water to prevent formation of abrasive dusts from the crystallization of dissolved solids in the water. The humidifier must be responsive to control, maintainable, and free of moisture carryover. See [Chapter 20 of the ASHRAE Handbook—HVAC Systems and Equipment](#) for more information on humidifiers.

When an air-side economizer is used, evaporative humidification should be considered because of its ability to use waste heat energy to meet humidification requirements. Water-side economizers are economically feasible in some climates but do not have the energy efficiency potential of air-side approaches and may not provide adequate dilution ventilation.

Chilled-Water Distribution Systems

Chilled-water distribution systems should be designed to the same standards of quality, reliability, and flexibility as other computer room support systems. Where growth is likely, the chilled-water system should be designed for expansion or addition of new equipment without extensive shutdown. [Figure 7](#) illustrates a looped chilled-water system with sectional valves and multiple valved branch connections. The branches could serve air handlers or water-cooled computer equipment. The valves permit modifications or repairs without complete shutdown.

Where chilled water serves packaged equipment in the computer room, water temperatures should be selected to satisfy the space sensible cooling loads while minimizing the risk of excessive condensation. Because computer room loads are primarily sensible, chilled water should be relatively warm. Water temperatures as high as 48°F are still slightly below the dew point of a 72°F, 45% rh room and further below that of a 72°F, 50% rh room.

Chilled-water and glycol piping must be pressure-tested, fully insulated, and protected with an effective vapor retarder. The test pressure should be applied in increments to all sections of pipe in the computer area. Drip pans piped to an effective drain should be placed below any valves or other components in the computer room that cannot be satisfactorily insulated. A good-quality strainer should be installed in the inlet to local cooling equipment to prevent control valve and heat exchanger passages from clogging.

If cross-connections with other systems are made, possible effects on the computer room system of the introduction of dirt, scale, or other impurities must be addressed.

Redundancy

System reliability is so vital that the potential cost of system failure may justify redundant systems, capacity, and/or components.

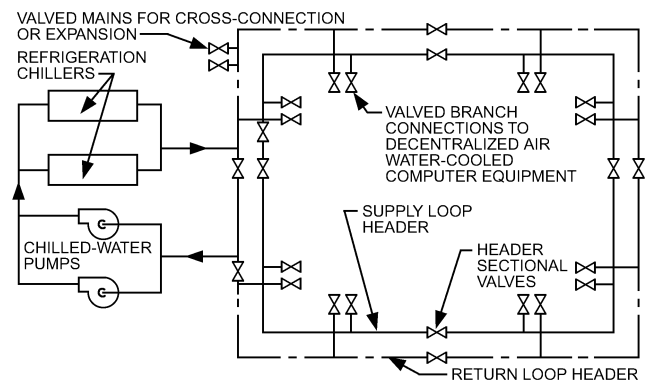

Fig. 7 Chilled-Water Loop Distribution

The designer should identify potential points of failure that could cause the system to interrupt critical data processing applications and should provide redundant or back-up systems.

It may be desirable to cross-connect chilled-water or refrigeration equipment for back-up, as suggested for air-handling equipment. Redundant refrigeration may be required; the extent of the redundancy depends on the importance of the computer installation. In many cases, standby power for the computer room air-conditioning system is justified.

Any complication to the basic conditioning system that might impair its reliability or otherwise adversely affect performance should be carefully considered before incorporating heat recovery into the design. Potential monetary loss from system malfunction or unscheduled shutdown may outweigh savings from increased operating efficiency.

INSTRUMENTATION

Because computer equipment malfunctions may be caused by or attributed to improper regulation of the computer room thermal environment, it may be desirable to keep permanent records of the space temperature and humidity. If air is supplied directly to computer equipment, these records can be correlated with equipment function.

Alarms should be provided to signal when temperature or humidity limits are violated. With water-cooled computers, records should be kept of the entering and exiting water temperature and pressure. Indicating thermometers and pressure gages should be placed throughout the system so that operators can tell at a glance when unusual conditions prevail. Properly maintained and accurate gages for air-handling equipment filters can help prevent loss of system capacity and maintain correct computer room conditions. Sensing devices to indicate leaks or the presence of water in the computer room underfloor cavity are desirable in spaces served by precision air-conditioning units, especially if brine or chilled-water distribution piping is installed in a computer room. Low points in drip pans installed beneath piping should also be monitored.

All monitoring and alarm devices should provide local indication. Monitoring devices may be interfaced with an integrated control or remote monitoring system that permits indications of system malfunctions to be transmitted to a remote location to initiate critical and maintenance alarms.

FIRE PROTECTION

Fire protection for the air-conditioning system should be integrated with fire protection for the computer room and for the whole facility. Applicable codes must be complied with, and the owner's insurers must be consulted. Automatic extinguishing systems afford the highest degree of protection. Fire underwriters often recommend an automatic sprinkler system. If a sprinkler system is used, it should be a preaction, dry type. Local annunciation of alarm points should be provided, and multiple-stage alarm and sprinkler system initiation should be used to prevent accidental sprinkler discharge.

Sensing devices should be placed in the occupied space, supply- and return-air passages, and the underfloor cavity (if it contains electric cables but is not used as an air supply plenum). These devices should provide early warning of combustion products, even if no smoke is visible and temperatures are at or near normal levels, to permit active measures to be taken to prevent damage or unscheduled shutdown of computer systems. All fire protection systems should provide for either manual or automatic shutdown of computer power, depending on the importance of the system and on the potential effect of an unwarranted shutdown (NFPA *Standard 70*).

Exhaust systems may be provided to ventilate computer rooms in the event of a fire suppression system discharge. Location of the exhaust pickup point below a supply plenum floor promotes quick purging of the space.

ENERGY CONSERVATION AND HEAT RECOVERY

Energy Conservation

Dramatic reductions in energy use can be achieved with conservation strategies. Where secondary uses for recovered heat do not exist or justify heat recovery, central station air-conditioning systems using outside air for free cooling, variable-volume ventilation, and evaporative cooling/humidification strategies offer significant opportunities for reducing energy use and improving air quality over precision air-conditioning systems. A dew-point control strategy can eliminate the need for troublesome humidity sensing devices and provide precise humidity control.

These same strategies may be used to provide efficient and cost-effective solutions on a larger scale within the electronic office and other support environments.

Heat Recovery

If a use for recovered energy exists, computer rooms are good candidates for heat recovery because of their large year-round loads. Heat rejected during condensing can be used for space heating, domestic water heating, or other process heat. If the heat removed by the conditioning system can be efficiently transferred and applied elsewhere in the facility, operational cost may be reduced.

UPS Areas

Modern uninterruptible power supply (UPS) areas typically use static equipment as opposed to rotary motor generator sets. Static UPS equipment must be air conditioned with sufficient redundancy to provide an operable system throughout an emergency or accident. Sizing the cooling equipment is typically driven by the configuration of the UPS. This equipment is usually configured to provide redundancy for the central power buses and operate continuously at less than full-load capacity. Heat release from this equipment is nonlinear. A typical value is 65% of full-load heat release at 50% capacity. Verification with the equipment vendor is necessary to properly size the HVAC system.

Air distribution is critical because UPS modules usually have self-contained cooling fans that draw air from the floor level or the face of the equipment and discharge the heated air at the top of the equipment. Horizontal airflow patterns in these spaces may lead to hot spots, causing the cooling and hot discharge air to mix, forcing fans to deliver air that is warmer than the desired air temperature. A more efficient solution is to discharge cooling air down to the floor near the corners of the modules, so as not to interfere with the hot discharge air from UPS fans. The cool airflow at the floor will be drawn into the equipment by recirculation fans. Air distribution should prevent cold drafts from blowing directly on maintenance workers while keeping equipment cool. This type of airflow pattern also requires a concentrated review of thermostat locations and the space. The airflow patterns required by the equipment should not impinge directly on thermostats.

BIBLIOGRAPHY

- ASHRAE. 2001. Method of testing for rating computer and data processing room unitary air conditioners. *Standard 127-2001*.
- Krzyzanowski, M.E. and B.T. Reagor. 1991. Measurement of potential contaminants in data processing environments. *ASHRAE Transactions* 97(1): 464-476.
- Lentz, M.S. 1991. Adiabatic saturation and VAV: A prescription for economy and close environmental control. *ASHRAE Transactions* 97(1):477-485.
- Longberg, J.C. 1991. Using a central air-handling unit system for environmental control of electronic data processing centers. *ASHRAE Transactions* 97(1):486-493.
- NFPA. 1999. *National electric code*[®]. NFPA *Standard 70*. National Fire Protection Association, Quincy, MA.
- Weschler, C.J. and H.C. Shields. 1991. The impact of ventilation and indoor air quality on electronic equipment. *ASHRAE Transactions* 97(1):455-463.