

SERVICE WATER HEATING

<i>System Planning</i>	49.1	<i>Residential</i>	49.9
<i>Water-Heating Equipment</i>	49.1	<i>Commercial and Institutional</i>	49.10
<i>Distribution</i>	49.4	<i>Sizing Examples</i>	49.12
<i>Terminal Hot-Water Usage Devices</i>	49.6	<i>Sizing Instantaneous and Semi-Instantaneous</i>	
<i>Water-Heating Terminology</i>	49.6	<i>Water Heaters</i>	49.19
<i>Design Considerations</i>	49.7	<i>Sizing Refrigerant-Based Water</i>	
<i>Water Quality, Scale, and Corrosion</i>	49.7	<i>Heaters</i>	49.21
<i>Safety Devices for Hot-Water Supplies</i>	49.7	<i>BOILERS FOR INDIRECT</i>	
<i>Special Concerns</i>	49.8	<i>WATER HEATING</i>	49.21
<i>HOT-WATER REQUIREMENTS AND STORAGE</i>		<i>Typical Control Sequence</i>	49.21
<i>EQUIPMENT SIZING</i>	49.9	<i>Codes and Standards</i>	49.22

A SERVICE water heating system has (1) a heat energy source, (2) heat transfer equipment, (3) a distribution system, and (4) terminal hot-water usage devices.

Heat energy sources may be (1) fuel combustion, (2) electrical conversion, (3) solar energy, and/or (4) recovered waste heat from such sources as flue gases, ventilation and air-conditioning systems, refrigeration cycles, and process waste discharge.

Heat transfer equipment is either direct or indirect. For direct equipment, heat is derived from combustion of fuel or direct conversion of electrical energy into heat and is applied within the water-heating equipment. For indirect heat transfer equipment, heat energy is developed from remote heat sources, such as boilers, solar energy collection, cogeneration, refrigeration, or waste heat, and is then transferred to the water in a separate piece of equipment. Storage tanks may be part of or associated with either type of heat transfer equipment.

Distribution systems transport the hot water produced by the water-heating equipment to terminal hot-water usage devices. The water consumed must be replenished from the building water service main. For locations where constant supply temperatures are desired, circulation piping or a means of heat maintenance must be provided.

Terminal hot-water usage devices are plumbing fixtures and equipment requiring hot water that may have periods of irregular flow, constant flow, and no flow. These patterns and their related water usage vary with different buildings, process applications, and personal preference.

In this chapter, it is assumed that an adequate supply of building service water is available. If this is not the case, alternative strategies such as water accumulation, pressure control, and flow restoration should be considered.

SYSTEM PLANNING

Flow rate and temperature are the primary factors to be determined in the hydraulic and thermal design of a water-heating and piping system. Operating pressures, time of delivery, and water quality are also factors to consider. Separate procedures are used to select water-heating equipment and to design the piping system.

Water-heating equipment, storage facilities, and piping should (1) have sufficient capacity to provide the required hot water while minimizing waste of energy or water and (2) allow economical system installation, maintenance, and operation.

The preparation of this chapter is assigned to TC 6.6, Service Water Heating.

Water-heating equipment types and designs are based on the (1) energy source, (2) application of the developed energy to heat the water, and (3) control method used to deliver the necessary hot water at the required temperature under varying water demand conditions. Application of water-heating equipment within the overall design of the hot-water system is based on (1) location of the equipment within the system, (2) related temperature requirements, and (3) volume of water to be used.

Energy Sources

The choice of energy source is influenced by the choices of equipment type and location. These decisions should be made only after evaluating purchase, installation, operating, and maintenance costs. A life-cycle analysis is highly recommended.

In making energy conservation choices, current editions of the following energy conservation guides should be consulted: the ANSI/ASHRAE/IES *Standard* 90 series or the sections on Service Water Heating of ANSI/ASHRAE/IESNA *Standard* 100 (see also the section on Design Considerations in this chapter).

WATER-HEATING EQUIPMENT

Gas-Fired Systems

Automatic storage water heaters incorporate the burner(s), storage tank, outer jacket, and controls in a single unit and have an input-to-storage capacity ratio of less than 4000 Btu/h per gallon or more and a thermostat to control energy input to the heater.

Automatic instantaneous water heaters are produced in two distinctly different types. Tank-type instantaneous heaters have an input-to-storage capacity ratio of 4000 Btu/h per gallon or more and a thermostat to control energy input to the heater. Water-tube instantaneous heaters have minimal water storage capacity. They usually have a flow switch that controls the burner, and may have a modulating fuel valve that varies fuel flow as water flow changes.

Circulating tank water heaters are classified in two types: (1) automatic, in which the thermostat is located in the water heater, and (2) nonautomatic, in which the thermostat is located within an associated storage tank.

Hot-water supply boilers are capable of providing service hot water. They are typically installed with separate storage tanks and applied as an alternative to circulating tank water heaters. Outside models are wind and rain tested. They are available in most of the classifications listed above.

Direct vent models are to be installed inside, but are not vented through a conventional chimney or gas vent and do not use ambient air for combustion. They must be installed with the means

specified by the equipment manufacturer for venting (typically horizontal) and for supplying combustion air from outside the building.

In **direct-fired systems**, cold water falls through a stainless steel heat exchange medium, which breaks up the water into very small droplets. These droplets then come into direct contact with heat rising from a flame, which heats the water directly.

Residential water-heating equipment is usually the automatic storage type. For industrial and commercial applications, commonly used types of heaters are (1) automatic storage, (2) circulating tank, (3) instantaneous, and (4) hot-water supply boilers.

Installation guidelines for gas-fired water heaters can be found in the National Fuel Gas Code, NFPA *Standard 54* (ANSI Z223.1). This code also covers the sizing and installation of venting equipment and controls.

Oil-Fired Systems

Oil-fired water heaters are generally the storage tank type. Models with a storage tank of 50 gal or less with an input rating of 105,000 Btu/h or less are usually considered residential models. Commercial models are offered in a wide range of input ratings and tank sizes. There are models available with combination gas/oil burners, which can be switched to burn either fuel, depending on local availability.

Installation guidelines for oil-fired water heaters can be found in NFPA *Standard 31*, Installation of Oil-Burning Equipment (ANSI Z95.1).

Electric

Electric water heaters are generally the storage type, consisting of a tank with one or more immersion heating elements. The heating elements consist of resistance wire embedded in refractories having good heat conduction properties and electrical insulating values. Heating elements are fitted into a threaded or flanged mounting for insertion into a tank. Thermostats controlling heating elements may be of the immersion or surface-mounted type.

Residential storage tank water heaters range up to 120 gal with input up to 12 kW. They have a primary resistance heating element near the bottom and often a secondary element located in the upper portion of the tank. Each element is controlled by its own thermostat. In dual-element heaters, the thermostats are usually interlocked so that the lower heating element cannot operate if the top element is operating. Thus, only one heating element operates at a time to limit the current draw.

Commercial storage tank water heaters are available in many combinations of element quantity, wattage, voltage, and storage capacity. Storage tanks may be horizontal or vertical. Compact, low-volume models are used in point-of-use applications to reduce hot-water piping length. Location of the water heater near the point of use makes recirculation loops unnecessary.

Instantaneous electric water heaters are sometimes used in lavatory, hot tub, whirlpool bath, and swimming pool applications. The smaller sizes are commonly used as boosters for dishwasher final rinse applications.

Heat-pump water heaters (HPWHs) use a vapor-compression refrigeration cycle to extract energy from an air or water source to heat water. Most HPWHs are air-to-water units. As the HPWH collects heat, it provides a potentially useful cooling effect and dehumidifies the air. HPWHs typically have a maximum output temperature of 140°F. Where a higher delivery temperature is required, a conventional storage-type or booster water heater downstream of the heat pump storage tank should be used. HPWHs function most efficiently where the inlet water temperature is low and the entering air is warm and humid. Systems should be sized to allow high HPWH run time. The effect of HPWH cooling output on

the building's energy balance should be considered. Cooling output should be directed to provide occupant comfort and avoid interfering with temperature-sensitive equipment (EPRI 1990).

Demand-controlled water heating can significantly reduce the cost of heating water electrically. Demand controllers operate on the principle that a building's peak electrical demand exists for a short period, during which heated water can be supplied from storage rather than through additional energy applications. Shifting the use of electricity for service water heating from peak demand periods allows water heating at the lowest electric energy cost in many electric rate schedules. The building electrical load must be detected and compared with peak demand data. When the load is below peak demand, the control device allows the water heater to operate. Some controllers can program deferred loads in steps as capacity is available. The priority sequence may involve each of several banks of elements in (1) a water heater, (2) multiple water heaters, or (3) water-heating and other equipment having a deferrable load, such as pool heating and snow melting. When load controllers are used, hot-water storage must be used.

Electric off-peak storage water heating is a water-heating equipment load management strategy whereby electrical demand to a water heating system is time-controlled, primarily in relation to the building or utility electrical load profile. This approach may require increased tank storage capacity and/or stored-water temperature to accommodate water use during peak periods.

Sizing recommendations in this chapter apply only to water heating without demand or off-peak control. When demand control devices are used, the storage and recovery rate may need to be increased to supply all the hot water needed during the peak period and during the ensuing recovery period. Manian and Chackeris (1974) include a detailed discussion on load-limited storage heating system design.

Indirect Water Heating

In indirect water heating, the heating medium is steam, hot water, or another fluid that has been heated in a separate generator or boiler. The water heater extracts heat through an external or internal heat exchanger.

When the heating medium is at a higher pressure than the service water, the service water may be contaminated by leakage of the heating medium through a damaged heat transfer surface. In the United States, some national, state, and local codes require double-wall, vented tubing in indirect water heaters to reduce the possibility of cross-contamination. When the heating medium is at a lower pressure than the service water, other jurisdictions allow single-wall tubing heaters because any leak would be into the heating medium.

If the heating medium is steam, high rates of condensation occur, particularly when a sudden demand causes an inflow of cold water. The steam pipe and condensate return pipes should be of ample size. Condensate should drain by gravity, without lifts, to a vented condensate receiver located below the level of the heater. Otherwise, water hammer, reduced capacity, or heater damage may result. The condensate may be cooled by preheating the cold-water supply to the heater.

Corrosion is minimized on the heating medium side of the heat exchanger because no makeup water, and hence no oxygen, is brought into that system. The metal temperature of the service water side of the heat exchanger is usually less than that in direct-fired water heaters. This minimizes scale formation from hard water.

Storage water heaters are designed for service conditions where hot-water requirements are not constant (i.e., where a large volume of heated water is held in storage for periods of peak load). The amount of storage required depends on the nature of the load and the recovery capacity of the water heater. An individual tank or several tanks joined by a manifold may be used to provide the required storage.

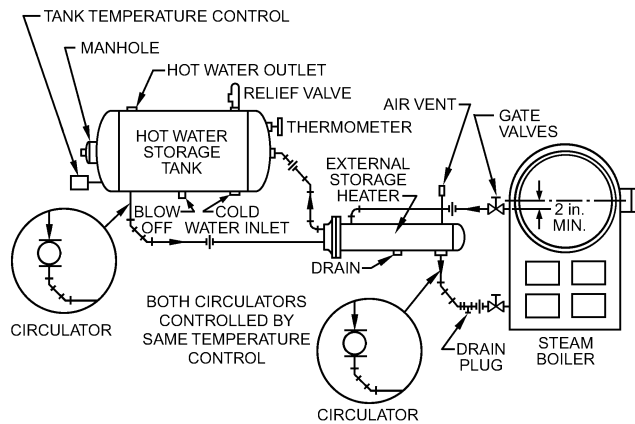

Fig. 1 Indirect, External Storage Water Heater

External storage water heaters are designed for connection to a separate tank (Figure 1). The boiler water circulates through the heater shell, while service water from the storage tank circulates through the tubes and back to the tank. Circulating pumps are usually installed in both the boiler water piping circuit and the circuits between the heat exchanger and the storage tank. Steam can also be used as the heating medium in a similar scheme.

Instantaneous indirect water heaters (tankless coils) are best used for a steady, continuous supply of hot water. In these units, the water is heated as it flows through the tubes. Because the heating medium flows through a shell, the ratio of hot-water volume to heating medium volume is small. As a result, variable flow of the service water causes uncertain temperature control unless a thermostatic mixing valve is used to maintain the hot-water supply to the plumbing fixtures at a more uniform temperature.

Some indirect instantaneous water heaters are located inside a boiler. The boiler is provided with a special opening through which the coil can be inserted. Although the coil can be placed in the steam space above the water line of a steam boiler, it is usually placed below the water line. The water heater transfers heat from the boiler water to the service water. The gross output of the boiler must be sufficient to serve all loads.

Semi-Instantaneous

These water heaters have limited storage to meet the average momentary surges of hot-water demand. They usually consist of a heating element and control assembly devised for close control of the temperature of the leaving hot water.

Circulating Tank

These water heaters are instantaneous or semi-instantaneous types used with a separate storage tank and a circulating pump. The storage acts as a flywheel to accommodate variations in the demand for hot water.

Blending Injection

These water heaters inject steam or hot water directly into the process or volume of water to be heated. They are often associated with point-of-use applications (e.g., certain types of commercial laundry, food, and process equipment). *Caution:* Cross-contamination of potable water is possible.

Solar

The availability of solar energy at the building site, the efficiency and cost of solar collectors, and the availability and cost of other fuels determine whether solar energy collection units should be used as a primary heat energy source. Solar energy equipment can

also be included to supplement other energy sources and conserve fuel or electrical energy.

The basic elements of a solar water heater include solar collectors, a storage tank, piping, controls, and a transfer medium. The system may use natural convection or forced circulation. Auxiliary heat energy sources may be added, if needed.

Collector design must allow operation in below-freezing conditions, where applicable. Antifreeze solutions in a separate collector piping circuit arrangement are often used, as are systems that allow water to drain back to heated areas when low temperatures occur. Uniform flow distribution in the collector or bank of collectors and stratification in the storage tank are important for good system performance.

The application of solar water heaters depends on (1) auxiliary energy requirements; (2) collector orientation; (3) temperature of the cold water; (4) general site, climatic, and solar conditions; (5) installation requirements; (6) area of collectors; and (7) amount of storage. [Chapter 33, Solar Energy Use](#), has more detailed design information.

Waste Heat Use

Waste heat recovery can reduce energy cost and the energy requirement of the building heating and service water-heating equipment. Waste heat can be recovered from equipment or processes by using appropriate heat exchangers in the hot gaseous or liquid streams. Heat recovered is frequently used to preheat the water entering the service water heater. Refrigeration heat reclaim uses refrigerant-to-water heat exchangers connected to the refrigeration circuit between the compressor and condenser of a host refrigeration or air-conditioning system to extract heat. Water is heated only when the host is operating at the same time there is a call for water heating. A conventional water heater is typically required to augment the output of the heat reclaim and to provide hot water during periods when the host system is not in operation.

Refrigeration Heat Reclaim

These systems heat water with heat that would otherwise be rejected through a refrigeration condenser. Because many simple systems reclaim only superheat energy from the refrigerant, they are often called *desuperheaters*. However, some units are also designed to provide partial or full condensing. The refrigeration heat reclaim heat exchanger is generally of vented, double-wall construction to isolate potable water from refrigerant. Some heat reclaim devices are designed for use with multiple refrigerant circuits. Controls are required to limit high water temperature, prevent low condenser pressure, and provide for freeze protection. Refrigeration systems with higher run time and lower efficiency provide more heat reclaim potential. Most systems are designed with a preheat water storage tank connected in series with a conventional water heater (EPRI 1992). In all installations, care must be taken to prevent inappropriately venting refrigerants.

Combination Heating

A **combo system** provides hot water for both space heating and domestic use. A space-heating coil and a space-cooling coil are often included with the air handler to provide year-round comfort. Combo systems also can use other types of heat exchangers for space heating, such as baseboard convectors or floor heating coils. A method of testing combo systems is given in *ASHRAE Standard 124*. The test procedures allow the calculation of Combined Annual Efficiency (CAE), as well as space-heating and water-heating efficiency factors. Kweiler (1992), Pietsch et al. (1994), Pietsch and Talbert (1989), Subherwal (1986), and Talbert et al. (1992) provide additional design information on these heaters.

DISTRIBUTION

Piping Material

Traditional piping materials have included galvanized steel used with galvanized malleable iron screwed fittings. Copper piping and copper water tube types K, L, or M have been used with brass, bronze, or wrought copper water solder fittings. Legislation or plumbing code changes have banned the use of lead in solders or pipe-jointing compounds in potable water piping because of possible lead contamination of the water supply. See the current ASHRAE *Standard 90* series for pipe insulation requirements.

Today, most potable water supplies require treatment before distribution; this may cause the water to become more corrosive. Therefore, depending on the water supply, traditional galvanized steel piping or copper tube may no longer be satisfactory, due to accelerated corrosion. Galvanized steel piping is particularly susceptible to corrosion (1) when hot water is between 140 and 180°F and (2) where repairs have been made using copper tube without a nonmetallic coupling.

Before selecting any water piping material or system, consult the local code authority. The local water supply authority should also be consulted about any history of water aggressiveness causing failures of any particular material.

Alternative piping materials that may be considered are (1) stainless steel tube and (2) various plastic piping and tubes. Particular care must be taken to ensure that the application meets the design limitations set by the manufacturer and that the correct materials and methods of joining are used. These precautions are easily taken with new projects but become more difficult during repairs of existing work. Using incompatible piping, fittings, and jointing methods or materials must be avoided, because they can cause severe problems.

Pipe Sizing

Sizing hot-water supply pipes involves the same principles as sizing cold-water supply pipes (see [Chapter 35 of the ASHRAE Handbook—Fundamentals](#)). The water distribution system must be correctly sized for the total hot-water system to function properly. Hot-water demand varies with the type of establishment, usage, occupancy, and time of day. The piping system should be capable of meeting peak demand at an acceptable pressure loss.

Supply Piping

[Table 13](#), [Figures 23](#) and [24](#), and manufacturers' specifications for fixtures and appliances can be used to determine hot-water demands. These demands, together with procedures given in [Chapter 35 of the ASHRAE Handbook—Fundamentals](#), are used to size the mains, branches, and risers.

Allowance for pressure drop through the heater should not be overlooked when sizing hot-water distribution systems, particularly where instantaneous water heaters are used and where the available pressure is low.

Pressure Differential

Sizing both cold- and hot-water piping requires that the pressure differential at the point of use of blended hot and cold water be kept to a minimum. This required minimum differential is particularly important for tubs and showers, because sudden changes in flow at fixtures cause discomfort and a possible scalding hazard. Pressure-compensating devices are available.

Return Piping

Return piping is commonly provided for hot-water systems in which it is desirable to have hot water available continuously at the fixtures. This includes cases where the hot-water piping exceeds 100 ft.

The water circulation pump may be controlled by a thermostat (in the return line) set to start and stop the pump over an acceptable temperature range. This thermostat can significantly reduce both heat loss and pumping energy in some applications. An automatic time switch or other control should turn the water circulation off when hot water is not required. Because hot water is corrosive, circulating pumps should be made of corrosion-resistant material.

For small installations, a simplified pump sizing method is to allow 1 gpm for every 20 fixture units in the system, or to allow 0.5 gpm for each 3/4 or 1 in. riser; 1 gpm for each 1 1/4 or 1 1/2 in. riser; and 2 gpm for each riser 2 in. or larger.

Werden and Spielvogel (1969) and Dunn et al. (1959) cover heat loss calculations for large systems. For larger installations, piping heat losses become significant. A quick method to size the pump and return for larger systems is as follows:

1. Determine the total length of all hot-water supply and return piping.
2. Choose an appropriate value for piping heat loss from [Table 1](#) or other engineering data (usually supplied by insulation companies, etc.). Multiply this value by the total length of piping involved.

Table 1 Approximate Heat Loss from Piping at 140°F Inlet, 70°F Ambient

Nominal Size, in.	Bare Copper Tubing, Btu/h·ft	1/2 in. Glass Fiber Insulated Copper Tubing, Btu/h·ft
3/4	30	17.7
1	38	20.3
1 1/4	45	23.4
1 1/2	53	25.4
2	66	29.6
2 1/2	80	33.8
3	94	39.5
4	120	48.4

A rough estimation can be made by multiplying the total length of covered pipe by 30 Btu/h·ft or uninsulated pipe by 60 Btu/h·ft. [Table 1](#) gives actual heat losses in pipes at a service water temperature of 140°F and ambient temperature of 70°F. The values of 30 or 60 Btu/h·ft are only recommended for ease in calculation.

3. Determine pump capacity as follows:

$$Q_p = \frac{q}{60\rho c_p \Delta t} \quad (1)$$

where

Q_p = pump capacity, gpm

q = heat loss, Btu/h

ρ = density of water = 8.25 lb/gal (120°F)

c_p = specific heat of water = 1 Btu/lb·°F

Δt = allowable temperature drop, °F

For a 20°F allowable temperature drop,

$$Q_p(\text{gpm}) = \frac{q}{60 \times 8.25 \times 1 \times 20} = \frac{q}{9900} \quad (2)$$

Caution: This calculation assumes that a 20°F temperature drop is acceptable at the last fixture.

4. Select a pump to provide the required flow rate, and obtain from the pump curves the pressure created at this flow.
5. Multiply the head by 100 and divide by the total length of hot water return piping to determine the allowable friction loss per 100 ft of pipe.

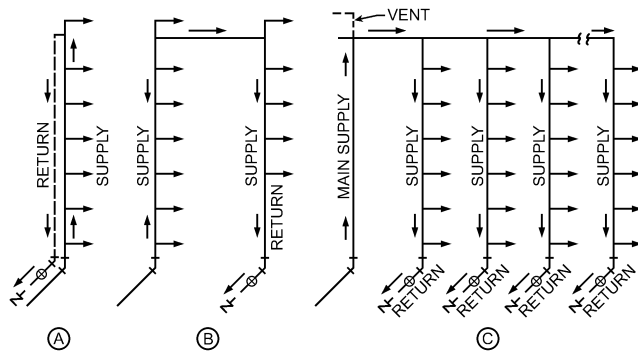

Fig. 2 Arrangements of Hot Water Circulation Lines

- Determine the required flow in each circulating loop, and size the hot water return pipe based on this flow and the allowable friction loss from Step 5.

Where multiple risers or horizontal loops are used, balancing valves with means of testing are recommended in the return lines. A swing-type check valve should be placed in each return to prevent entry of cold water or reversal of flow, particularly during periods of high hot-water demand.

Three common methods of arranging circulation lines are shown in Figure 2. Although the diagrams apply to multistory buildings, arrangements (A) and (B) are also used in residential designs. In circulation systems, air venting, pressure drops through the heaters and storage tanks, balancing, and line losses should be considered. In Figures 2A and 2B, air is vented by connecting the circulating line below the top fixture supply. With this arrangement, air is eliminated from the system each time the top fixture is opened. Generally, for small installations, a nominal pipe size (NPS) 1/2 or 3/4 in. hot-water return is ample.

All storage tanks and piping on recirculating systems should be insulated as recommended by the ASHRAE *Standard 90* series and *Standard 100*.

Heat-Traced, Nonreturn Piping

In this system, the fixtures can be as remote as in the return piping. The hot-water supply piping is heat traced with electric resistance heating cable preinstalled under the pipe insulation. Electrical energy input is self-regulated by the cable's construction to maintain the required water temperature at the fixtures. No return piping system or circulation pump is required.

Special Piping—Commercial Dishwashers

Adequate flow rate and pressure must be maintained for automatic dishwashers in commercial kitchens. To reduce operating difficulties, piping for automatic dishwashers should be installed according to the following recommendations:

- The cold-water feed line to the water heater should be no smaller than NPS 1.
- The supply line that carries 180°F water from the water heater to the dishwasher should not be smaller than NPS 3/4.
- No auxiliary feed lines should connect to the 180°F supply line.
- A return line should be installed if the source of 180°F water is more than 5 ft from the dishwasher.
- Forced circulation by a pump should be used if the water heater is installed on the same level as the dishwasher, if the length of return piping is more than 60 ft, or if the water lines are trapped.
- If a circulating pump is used, it is generally installed in the return line. It may be controlled by (a) the dishwasher wash switch, (b) a manual switch located near the dishwasher, or (c) an immersion or strap-on thermostat located in the return line.

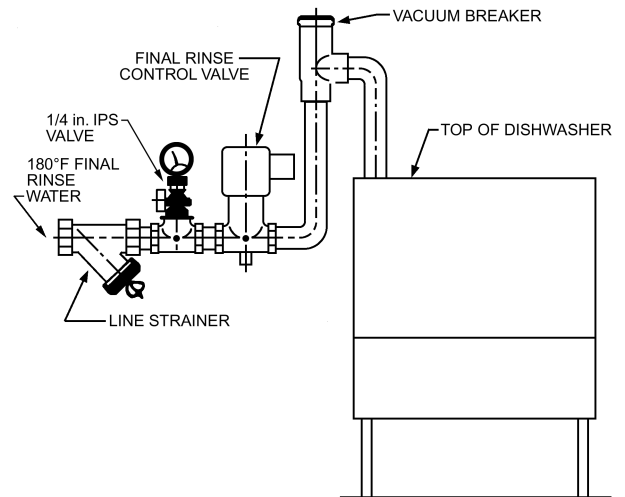

Fig. 3 National Sanitation Foundation (NSF) Plumbing Requirements for Commercial Dishwasher

- A pressure-reducing valve should be installed in the low-temperature supply line to a booster water heater, but external to a recirculating loop. It should be adjusted, with the water flowing, to the value stated by the washer manufacturer (typically 20 psi).
- A check valve should be installed in the return circulating line.
- If a check-valve water meter or a backflow prevention device is installed in the cold-water line ahead of the heater, it is necessary to install a properly sized diaphragm-type expansion tank between the water meter or prevention device and the heater.
- National Sanitation Foundation (NSF) Standards require the installation of an NPS 1/4 IPS connection for a pressure gage mounted adjacent to the supply side of the control valve. They also require a water line strainer ahead of any electrically operated control valve (Figure 3).
- NSF Standards do not allow copper water lines that are not under constant pressure, except for the line downstream of the solenoid valve on the rinse line to the cabinet.

Water Pressure—Commercial Kitchens

Proper flow pressure must be maintained to achieve efficient dishwashing. NSF standards for dishwasher water flow pressure are 15 psig minimum, 25 psig maximum, and 20 psig ideal. Flow pressure is the line pressure measured when water is flowing through the rinse arms of the dishwasher.

Low flow pressure can be caused by undersized water piping, stoppage in piping, or excess pressure drop through heaters. Low water pressure causes an inadequate rinse, resulting in poor drying and sanitizing of the dishes. If flow pressure in the supply line to the dishwasher is below 15 psig, a booster pump or other means should be installed to provide supply water at 20 psig.

A flow pressure in excess of 25 psig causes atomization of the 180°F rinse water, resulting in an excessive temperature drop. The temperature drop between the rinse nozzle and the dishes can be as much as 15°F. A pressure regulator should be installed in the supply water line adjacent to the dishwasher and external to the return circulating loop (if used). The regulator should be set to maintain a pressure of 20 psig.

Two-Temperature Service

Where multiple temperature requirements are met by a single system, the system temperature is determined by the maximum temperature needed. Where the bulk of the hot water is needed at the higher temperature, lower temperatures can be obtained by mixing hot and cold water. Automatic mixing valves reduce the

temperature of the hot water available at certain outlets to prevent injury or damage (Figure 4). Applicable codes should be consulted for mixing valve requirements.

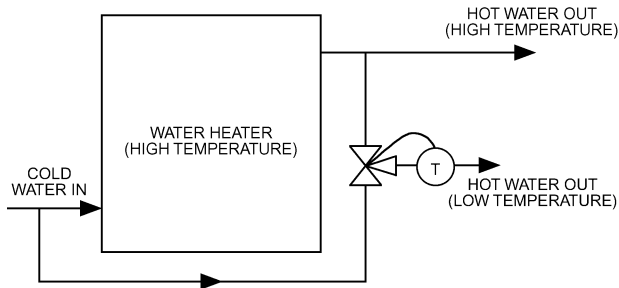

Fig. 4 Two-Temperature Service with Mixing Valve

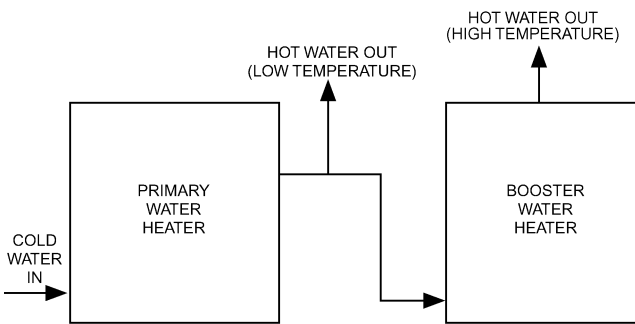

Fig. 5 Two-Temperature Service with Primary Heater and Booster Heater in Series

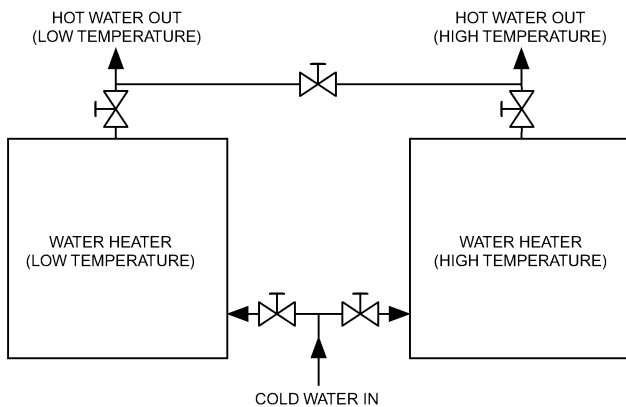

Fig. 6 Two-Temperature Service with Separate Heater for Each Service

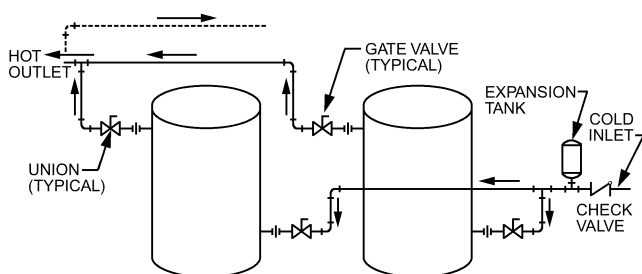

Fig. 7 Reverse/Return Manifold Systems

Where predominant use is at a lower temperature, the common design heats all water to the lower temperature and then uses a separate booster heater to further heat the water for the higher-temperature service (Figure 5). This method offers better protection against scalding.

A third method uses separate heaters for the higher-temperature service (Figure 6). It is common practice to cross-connect the two heaters, so that one heater can serve the complete installation temporarily while the other is valved off for maintenance. Each heater should be sized for the total load unless hot-water consumption can be reduced during maintenance periods.

Manifolding

Where one heater does not have sufficient capacity, two or more water heaters may be installed in parallel. If blending is needed in such an installation, a single mixing valve of adequate capacity should be used. It is difficult to obtain even flow through parallel mixing valves.

Heaters installed in parallel should have similar specifications: the same input and storage capacity, with inlet and outlet piping arranged so that an equal flow is received from each heater under all demand conditions.

An easy way to get balanced, parallel flow is to use reverse/return piping (Figure 7). The unit having its inlet closest to the cold-water supply is piped so that its outlet will be farthest from the hot-water supply line. Quite often this results in a hot-water supply line that reverses direction (see dashed line, Figure 7) to bring it back to the first unit in line; hence the name reverse/return.

TERMINAL HOT-WATER USAGE DEVICES

Details on the vast number of devices using service hot water are beyond the scope of this chapter. Nonetheless, they are important to a successful overall design. Consult the manufacturer’s literature for information on required flow rates, temperature limits, and/or other operating factors for specific items.

WATER-HEATING TERMINOLOGY

The following terms apply to water heaters and water heating:

Recovery efficiency. Heat absorbed by the water divided by the heat input to the heating unit during the period that water temperature is raised from inlet temperature to final temperature.

Recovery rate. The amount of hot water that a residential water heater can continually produce, usually reported as flow rate in gallons per hour that can be maintained for a specified temperature rise through the water heater.

Fixture unit. A number, on an arbitrarily chosen scale, that expresses the load-producing effects on the system of different kinds of fixtures.

Thermal efficiency. Heat in the water flowing from the heater outlet divided by the heat input of the heating unit over a specific period of steady-state conditions.

Energy factor. The delivered efficiency of a water heater when operated as specified in U.S. Department of Energy (DOE) test procedures (10 CFR Part 430).

First hour rating. An indicator of the amount of hot water a residential water heater can supply. This rating is used by the Federal Trade Commission (FTC) for comparative purposes.

Standby loss. As applied to a tank type water heater (under test conditions with no water flow), the average hourly energy consumption divided by the average hourly heat energy contained in the stored water, expressed as a percent per hour. This can be converted to the average Btu/h energy consumption required to maintain any water-air temperature difference by multiplying the percent by the temperature difference, 8.25 Btu/gal·°F (a nominal specific heat for water), the tank capacity, and then dividing by 100.

Hot-water distribution efficiency. Heat contained in the water at points of use divided by the heat delivered at the heater outlet at a given flow.

Heater/system efficiency. Heat contained in the water at points of use divided by the heat input to the heating unit at a given flow rate (thermal efficiency times distribution efficiency).

Heat trap. A device to counteract the natural convection of heated water in a vertical pipe. Commercially available heat traps are generally 360° loops of tubing; heat traps can also be constructed of pipes connected to the water heater (inlet or outlet) that direct flow downward before connecting to the vertical supply or hot-water distribution system. Tubing or piping heat traps should have a loop diameter or length of downward piping of at least 12 in.

Overall system efficiency. Heat energy in the water delivered at points of use divided by the total energy supplied to the heater for any selected period.

System standby loss. The amount of heat lost from the water heating system and the auxiliary power consumed during periods of nonuse of service hot water.

DESIGN CONSIDERATIONS

Hot-water system design should consider the following:

- Water heaters of different sizes and insulation may have different standby losses, recovery efficiency, thermal efficiency, or energy factors.
- A distribution system should be properly designed, sized, and insulated to deliver adequate water quantities at temperatures satisfactory for the uses served. This reduces standby loss and improves hot-water distribution efficiency.
- Heat traps between recirculation mains and infrequently used branch lines reduce convection losses to these lines and improve heater/system efficiency. In small residential systems, heat traps can be applied directly to the water heater for the same purpose.
- Controlling circulating pumps to operate only as needed to maintain proper temperature at the end of the main reduces losses on return lines.
- Provision for shutdown of circulators during building vacancy reduces standby losses.

WATER QUALITY, SCALE, AND CORROSION

A complete water analysis and an understanding of system requirements are needed to protect water-heating systems from scale and corrosion. Analysis shows whether water is hard or soft. Hard water, unless treated, will cause scaling or liming of heat transfer and water storage surfaces; soft water may aggravate corrosion problems and anode consumption (Talbert et al. 1986).

Scale formation is also affected by system requirements and equipment. As shown in [Figure 8](#), the rate of scaling increases with temperature and usage because calcium carbonate and other scaling compounds lose solubility at higher temperatures. In water tube-type equipment, scaling problems can be offset by increasing the water velocity over the heat transfer surfaces, which reduces the tube surface temperature. Also, the turbulence of the flow, if high enough, works to keep any scale that does precipitate off the surface. When water hardness is over 8 gr/gal, water softening or other water treatment is often recommended.

Corrosion problems increase with temperature because corrosive oxygen and carbon dioxide gases are released from the water. Electrical conductivity also increases with temperature, enhancing electrochemical reactions such as rusting (Toaborek et al. 1972). A deposit of scale provides some protection from corrosion; however, this deposit also reduces the heat transfer rate, and it is not under the control of the system designer (Talbert et al. 1986).

Steel vessels can be protected to varying degrees by galvanizing them or by lining them with copper, glass, cement, electroless

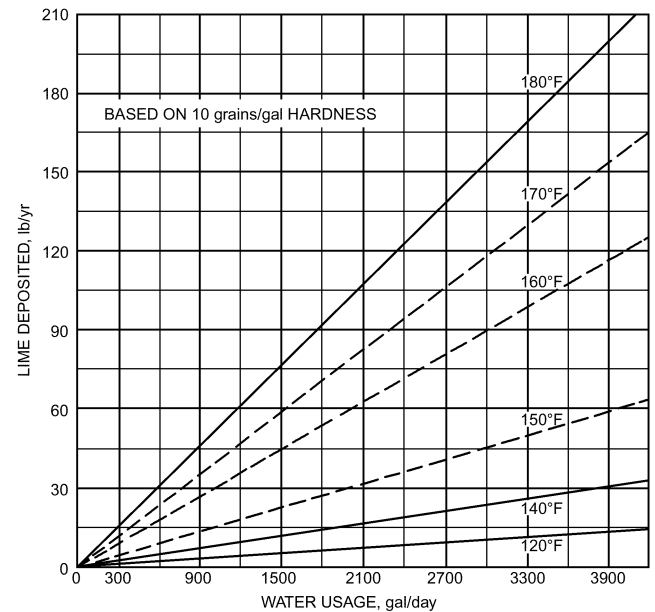

Fig. 8 Lime Deposited Versus Temperature and Water Use
(Based on data from Purdue University Bulletin No. 74)

nickel-phosphorus, or other corrosion-resistant material. Glass-lined vessels are almost always supplied with electrochemical protection. Typically, one or more anode rods of magnesium, aluminum, or zinc alloy are installed in the vessel by the manufacturer. This electrochemically active material sacrifices itself to reduce or prevent corrosion of the tank (the cathode). A higher temperature, softened water, and high water use may lead to rapid anode consumption. Manufacturers recommend periodic replacement of the anode rod(s) to prolong the life of the vessel. Some waters have very little electrochemical activity. In this instance, a standard anode shows little or no activity, and the vessel is not adequately protected. If this condition is suspected, the equipment manufacturer should be consulted on the possible need for a high potential anode, or the use of vessels made of nonferrous material should be considered.

Water heaters and hot-water storage tanks constructed of stainless steel, copper, or other nonferrous alloys are protected against oxygen corrosion. However, care must still be taken, as some stainless steel may be adversely affected by chlorides, and copper may be attacked by ammonia or carbon dioxide.

SAFETY DEVICES FOR HOT-WATER SUPPLIES

Regulatory agencies differ as to the selection of protective devices and methods of installation. It is therefore essential to check and comply with the manufacturer's instructions and the applicable local codes. In the absence of such instructions and codes, the following recommendations may be used as a guide:

- Water expands when it is heated. Although the water-heating system is initially under service pressure, the pressure will rise rapidly if backflow is prevented by devices such as a check valve, pressure-reducing valve, or backflow preventer in the cold-water line or by temporarily shutting off the cold water valve. When backflow is prevented, the pressure rise during heating may cause the safety relief valve to weep to relieve the pressure. However, if the safety relief valve is inadequate, inoperative, or missing, the pressure rise may rupture the tank or cause other damage. Systems having this potential problem must be protected by a properly sized expansion tank located on the cold-water line downstream of and as close as practical to the device preventing back flow.

- Temperature-limiting devices (energy cutoff/high limit) prevent water temperatures from exceeding 210°F by stopping the flow of fuel or energy. These devices should be listed and labeled by a recognized certifying agency.
- Safety relief valves open when the pressure exceeds the valve setting. These valves are typically applied to water heating and hot-water supply boilers. The set pressure should not exceed the maximum allowable working pressure of the boiler. The heat input pressure steam rating (in Btu/h) should equal or exceed the maximum output rating for the boiler. The valves should comply with current applicable standards or the ASME *Boiler and Pressure Vessel Code*.
- Temperature and pressure safety relief valves also open if the water temperature reaches 210°F. These valves are typically applied to water heaters and hot-water storage tanks. The heat input temperature/steam rating (in Btu/h) should equal or exceed the heat input rating of the water heater. Combination temperature- and pressure-relief valves should be installed with the temperature-sensitive element located in the top 6 in. of the tank (i.e., where the water is hottest).
- To reduce scald hazards, discharge temperature at fixtures accessible to the occupant should not exceed 120°F. Thermostatically controlled mixing valves can be used to blend hot and cold water to maintain safe service hot-water temperatures.
- A relief valve should be installed in any part of the system containing a heat input device that can be isolated by valves. The heat input device may be solar water-heating panels, desuperheater water heaters, heat recovery devices, or similar equipment.

SPECIAL CONCERNS

Legionella pneumophila (Legionnaires' Disease)

Legionnaires' disease (a form of severe pneumonia) is caused by inhaling the bacteria *Legionella pneumophila*. It has been discovered in the service water systems of various buildings throughout the world. Infection has often been traced to *Legionella pneumophila* colonies in shower heads. Ciesielki et al. (1984) determined that *Legionella pneumophila* can colonize in hot water maintained at 115°F or lower. Segments of service water systems in which the water stagnates (e.g., shower heads, faucet aerators, and certain sections of storage-type water heaters) provide ideal breeding locations.

Service water temperature in the 140°F range is recommended to limit the potential for *Legionella pneumophila* growth. This high temperature increases the potential for scalding, so care must be taken such as installing an anti-scald or mixing valve. Supervised periodic flushing of fixture heads with 170°F water is recommended in hospitals and health care facilities because the already weakened patients are generally more susceptible to infection.

More information on this subject can be found in ASHRAE *Guideline 12-2000, Minimizing the Risk of Legionellosis Associated with Building Water Systems*.

Temperature Requirement

Typical temperature requirements for some services are shown in [Table 2](#). A 140°F water temperature minimizes flue gas condensation in the equipment.

Hot Water from Tanks and Storage Systems

With storage systems, 60 to 80% of the hot water in a tank is assumed to be usable before dilution by cold water lowers the temperature below an acceptable level. However, better designs can exceed 90%. Thus, the hot water available from a self-contained storage heater is usually considered to be

$$V_t = R_d + M S_t \quad (3)$$

Table 2 Representative Hot-Water Temperatures

Use	Temperature, °F
Lavatory	
Hand washing	105
Shaving	115
Showers and tubs	110
Therapeutic baths	95
Commercial or institutional laundry, based on fabric	up to 180
Residential dish washing and laundry	140
Surgical scrubbing	110
Commercial spray-type dish washing ^a	
Single- or multiple-tank hood or rack type	
Wash	150 minimum
Final rinse	180 to 195
Single-tank conveyor type	
Wash	160 minimum
Final rinse	180 to 195
Single-tank rack or door type	
Single-temperature wash and rinse	165 minimum
Chemical sanitizing types ^b	140
Multiple-tank conveyor type	
Wash	150 minimum
Pumped rinse	160 minimum
Final rinse	180 to 195
Chemical sanitizing glass washer	
Wash	140
Rinse	75 minimum

^aAs required by NSF.

^bSee manufacturer for actual temperature required.

where

- V_t = available hot water, gal
- R = recovery rate at required temperature, gph
- d = duration of peak hot-water demand, h
- M = ratio of usable water to storage tank capacity
- S_t = storage capacity of heater tank, gal

Usable hot water from an unfired tank is

$$V_a = M S_a \quad (4)$$

where

- V_a = usable water available from unfired tank, gal
- S_a = capacity of unfired tank, gal

Note: Assumes tank water at required temperature.

Hot water obtained from a water heater using a storage heater with an auxiliary storage tank is

$$V_z = V_t + V_a = R d + M(S_t + S_a) \quad (5)$$

where V_z = total hot water available during one peak, in gallons.

Placement of Water Heaters

Many types of water heaters may be expected to leak at the end of their useful life. They should be placed where such leakage will not cause damage. Alternatively, suitable drain pans piped to drains must be provided.

Water heaters not requiring combustion air may generally be placed in any suitable location, as long as relief valve discharge pipes open to a safe location.

Water heaters requiring ambient combustion air must be located in areas with air openings large enough to admit the required combustion/dilution air (see NFPA *Standard 54/ANSI Z223.1*).

For water heaters located in areas where flammable vapors are likely to be present, precautions should be taken to eliminate the

probable ignition of flammable vapors. For water heaters installed in residential garages, additional precautions should be taken. Consult local codes for additional requirements or see sections 5.1.9 through 5.1.12 of NFPA *Standard 54/ANSI Z223.1*.

Outside models with a weather-proofed jacket are available. Direct-vent gas- and oil-fired models are also available; they are to be installed inside, but are not vented via a conventional chimney or gas vent. They use ambient air for combustion. They must be installed with the means specified by the manufacturer for venting (typically horizontal) and for supplying air for combustion from outside the building.

HOT-WATER REQUIREMENTS AND STORAGE EQUIPMENT SIZING

Methods for sizing storage water heaters vary. Those using recovery versus storage curves are based on extensive research. All methods provide adequate hot water if the designer allows for unusual conditions.

RESIDENTIAL

[Table 3](#) shows typical hot-water usage in a residence. In its Minimum Property Standards for One- and Two-Family Living Units, No. 4900.1-1982, HUD-FHA established minimum permissible water heater sizes ([Table 4](#)). Storage water heaters may vary from the sizes shown in the table if combinations of recovery and storage are used that produce the required 1 h draw.

The first hour rating (FHR) is the amount of hot water that the water heater can supply in one hour of operation under specific test conditions (DOE 1998). The FHR is under review regarding its use for system sizing. The linear regression lines shown in [Figure 9](#) represent the FHR for 1556 electric heaters and 2901 gas heaters (GAMA 1997; Hiller 1998). Regression lines are not

included for oil-fired and heat-pump water heaters because of limited data. The FHR represents water-heater performance characteristics that are similar to those represented by the 1 h draw values listed in [Table 4](#).

Another factor to consider when sizing water heaters is the set-point temperature. At lower storage tank water temperatures, the tank volume and/or energy input rate may need to be increased to meet a given hot-water demand. Currently, manufacturers are shipping residential water heaters with a recommendation that the initial set point be approximately 120°F to minimize the potential for scalding. Reduced set points generally lower standby losses and increase the water heater’s efficiency and recovery capacity but may also reduce the amount of hot water available.

Over the last decade, the structure and lifestyle of a typical family have altered the household’s hot-water consumption. Variations in family size, age of family members, presence and age of children, hot-water use volume and temperature, and other factors cause demand patterns to fluctuate widely in both magnitude and time distribution.

Perlman and Mills (1985) developed the overall and peak average hot-water use volumes shown in [Table 5](#). Average hourly

Table 3 Typical Residential Use of Hot Water

Use	High Flow,	Low Flow
	Gallons/Task	(Water Savers Used), Gallons/Task
Food preparation	5	3
Hand dish washing	4	4
Automatic dishwasher	15	15
Clothes washer	32	21
Shower or bath	20	15
Face and hand washing	4	2

Table 4 HUD-FHA Minimum Water Heater Capacities for One- and Two-Family Living Units

Number of Baths	1 to 1.5			2 to 2.5				3 to 3.5			
	1	2	3	2	3	4	5	3	4	5	6
Number of Bedrooms											
GAS^a											
Storage, gal	20	30	30	30	40	40	50	40	50	50	50
1000 Btu/h input	27	36	36	36	36	38	47	38	38	47	50
1 h draw, gal	43	60	60	60	70	72	90	72	82	90	92
Recovery, gph	23	30	30	30	30	32	40	32	32	40	42
ELECTRIC^a											
Storage, gal	20	30	40	40	50	50	66	50	66	66	80
kW input	2.5	3.5	4.5	4.5	5.5	5.5	5.5	5.5	5.5	5.5	5.5
1 h draw, gal	30	44	58	58	72	72	88	72	88	88	102
Recovery, gph	10	14	18	18	22	22	22	22	22	22	22
OIL^a											
Storage, gal	30	30	30	30	30	30	30	30	30	30	30
1000 Btu/h input	70	70	70	70	70	70	70	70	70	70	70
1 h draw, gal	89	89	89	89	89	89	89	89	89	89	89
Recovery, gph	59	59	59	59	59	59	59	59	59	59	59
TANK-TYPE INDIRECT^{b,c}											
I-W-H-rated draw, gal in 3 h, 100°F rise		40	40		66	66 ^e	66	66	66	66	66
Manufacturer-rated draw, gal in 3 h, 100°F rise		49	49		75	75 ^e	75	75	75	75	75
Tank capacity, gal		66	66		66	66 ^e	82	66	82	82	82
TANKLESS-TYPE INDIRECT^{c,d}											
I-W-H-rated draw, gpm, 100°F rise		2.75	2.75		3.25	3.25 ^e	3.75	3.25	3.75	3.75	3.75
Manufacturer-rated draw, gal in 5 min, 100°F rise		15	15		25	25 ^e	35	25	35	35	35

^aStorage capacity, input, and recovery requirements indicated in the table are typical and may vary with each individual manufacturer. Any combination of these requirements to produce the stated 1 h draw will be satisfactory.

^bBoiler-connected water heater capacities (180°F boiler water, internal, or external connection).

^cHeater capacities and inputs are minimum allowable. Variations in tank size are permitted when recovery is based on 4 gph/kW at 100°F rise for electrical, AGA recovery ratings for gas, and IBR ratings for steam and hot water heaters.

^dBoiler-connected heater capacities (200°F boiler water, internal, or external connection).

^eAlso for 1 to 1.5 baths and 4 bedrooms for indirect water heaters.

Table 5 Overall (OVL) and Peak Average Hot-Water Use

Group	Average Hot-Water Use, gal							
	Hourly		Daily		Weekly		Monthly	
	OVL	Peak	OVL	Peak	OVL	Peak	OVL	Peak
All families	2.6	4.6	62.4	67.1	436	495	1897	2034
"Typical" families	2.6	5.8	63.1	66.6	442	528	1921	2078

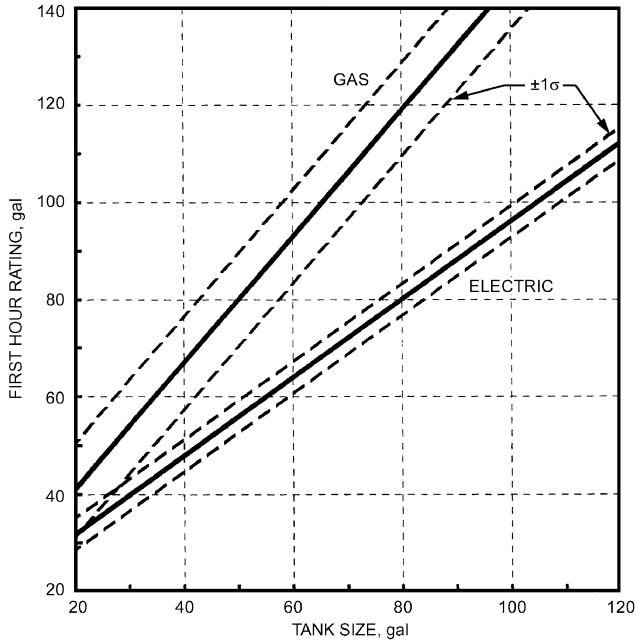

Fig. 9 First Hour Rating Relationships for Residential Water Heaters

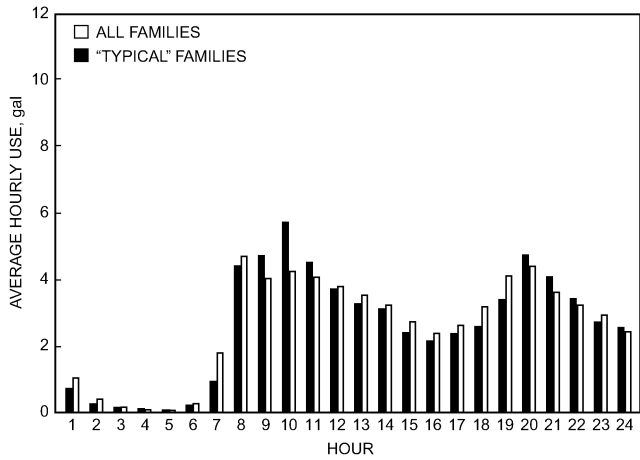

Fig. 10 Residential Average Hourly Hot-Water Use

patterns and 95% confidence level profiles are illustrated in [Figures 10 and 11](#). Samples of results from the analysis of similarities in hot-water use are given in [Figures 12 and 13](#).

COMMERCIAL AND INSTITUTIONAL

Most commercial and institutional establishments use hot or warm water. The specific requirements vary in total volume, flow rate, duration of peak load period, and temperature. Water heaters and systems should be selected based on these requirements.

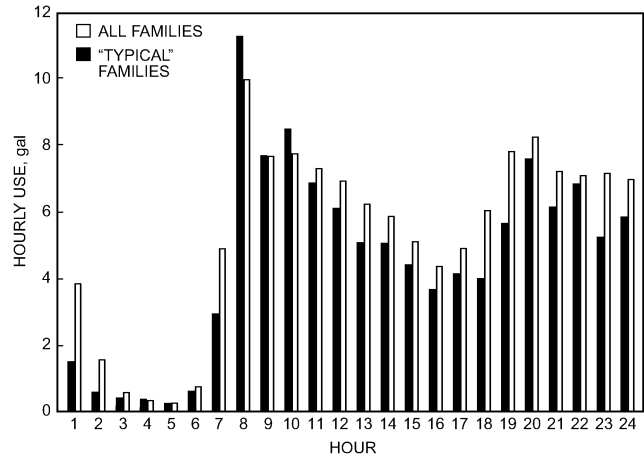

Fig. 11 Residential Hourly Hot-Water Use—95% Confidence Level

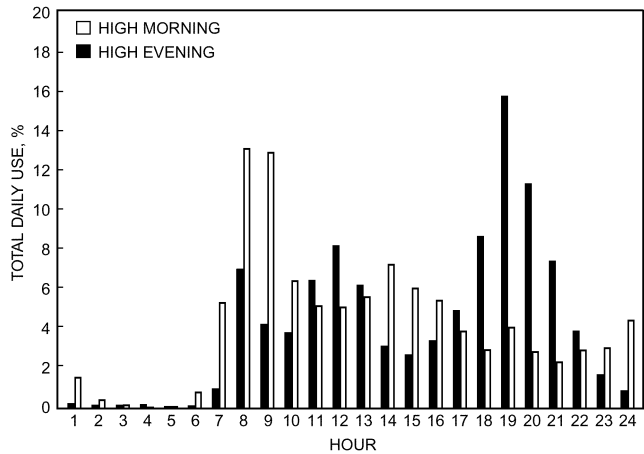

Fig. 12 Residential Hourly Water Use Pattern for Selected High Morning and High Evening Users

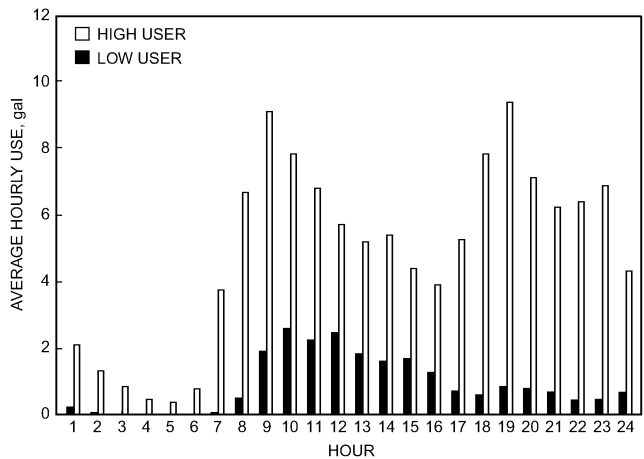

Fig. 13 Residential Average Hourly Hot-Water Use for Low and High Users

This section covers sizing recommendations for central storage water-heating systems. Hot-water usage data and sizing curves for dormitories, motels, nursing homes, office buildings, food service

Table 6 Hot-Water Demands and Use for Various Types of Buildings

Type of Building	Maximum Hourly	Maximum Daily	Average Daily
Men's dormitories	3.8 gal/student	22.0 gal/student	13.1 gal/student
Women's dormitories	5.0 gal/student	26.5 gal/student	12.3 gal/student
Motels: Number of units ^a			
20 or less	6.0 gal/unit	35.0 gal/unit	20.0 gal/unit
60	5.0 gal/unit	25.0 gal/unit	14.0 gal/unit
100 or more	4.0 gal/unit	15.0 gal/unit	10.0 gal/unit
Nursing homes	4.5 gal/bed	30.0 gal/bed	18.4 gal/bed
Office buildings	0.4 gal/person	2.0 gal/person	1.0 gal/person
Food service establishments			
Type A—full meal restaurants and cafeterias	1.5 gal/max meals/h	11.0 gal/max meals/day	2.4 gal/average meals/day ^b
Type B—drive-ins, grilles, luncheonettes, sandwich, and snack shops	0.7 gal/max meals/h	6.0 gal/max meals/day	0.7 gal/average meals/day ^b
Apartment houses: Number of apartments			
20 or less	12.0 gal/apartment	80.0 gal/apartment	42.0 gal/apartment
50	10.0 gal/apartment	73.0 gal/apartment	40.0 gal/apartment
75	8.5 gal/apartment	66.0 gal/apartment	38.0 gal/apartment
100	7.0 gal/apartment	60.0 gal/apartment	37.0 gal/apartment
200 or more	5.0 gal/apartment	50.0 gal/apartment	35.0 gal/apartment
Elementary schools	0.6 gal/student	1.5 gal/student	0.6 gal/student ^b
Junior and senior high schools	1.0 gal/student	3.6 gal/student	1.8 gal/student ^b

^aInterpolate for intermediate values.^bPer day of operation.

establishments, apartments, and schools are based on EEI-sponsored research (Werden and Spielvogel 1969). Caution must be taken in applying these data to small buildings. Also, within any given category there may be significant variation. For example, the motel category encompasses standard, luxury, resort, and convention motels.

When additional hot-water requirements exist, increase the recovery and/or storage capacity accordingly. For example, if there is food service in an office building, the recovery and storage capacities required for each additional hot-water use should be added when sizing a single central water heating system.

Peak hourly and daily demands for various categories of commercial and institutional buildings are shown in [Table 6](#). These demands for central-storage hot-water represent the maximum flows metered in this 129-building study, excluding extremely high and very infrequent peaks. [Table 6](#) also shows average hot-water consumption figures for these buildings. Averages for schools and food service establishments are based on actual days of operation; all others are based on total days. These averages can be used to estimate monthly consumption of hot water.

Research conducted for ASHRAE (Becker et al. 1991; Thrasher and DeWerth 1994) and others (Goldner 1994a, 1994b) included a compilation and review of service hot-water use information in commercial and multifamily structures along with new monitoring data. Some of this work found consumption comparable to those shown in [Table 6](#); however, many of the studies showed higher consumption.

Dormitories

Hot-water requirements for college dormitories generally include showers, lavatories, service sinks, and clothes washers. Peak demand usually results from the use of showers. Load profiles and hourly consumption data indicate that peaks may last 1 or 2 h and then taper off substantially. Peaks occur predominantly in the evening, mainly around midnight. The figures do not include hot water used for food service.

Military Barracks

Design criteria for military barracks are available from the engineering departments of the U.S. Department of Defense. Some measured data exist for hot-water use in these facilities. For published

data, contact the U.S. Army Corps of Engineers or Naval Facilities Engineering Command.

Motels

Domestic hot-water requirements are for tubs and showers, lavatories, and general cleaning purposes. Recommendations are based on tests at low- and high-rise motels located in urban, suburban, rural, highway, and resort areas. Peak demand, usually from shower use, may last 1 or 2 h and then drop off sharply. Food service, laundry, and swimming pool requirements are not included.

Nursing Homes

Hot water is required for tubs and showers, wash basins, service sinks, kitchen equipment, and general cleaning. These figures include hot water for kitchen use. When other equipment, such as that for heavy laundry and hydrotherapy purposes, is to be used, its hot-water requirement should be added.

Office Buildings

Hot-water requirements are primarily for cleaning and lavatory use by occupants and visitors. Hot-water use for food service within office buildings is not included.

Food Service Establishments

Hot-water requirements are primarily for dish washing. Other uses include food preparation, cleaning pots and pans and floors, and hand washing for employees and customers. The recommendations are for establishments serving food at tables, counters, booths, and parked cars. Establishments that use disposable service exclusively are not covered in [Table 6](#).

Dish washing, as metered in these tests, is based on normal practice of dish washing after meals, not on indiscriminate or continuous use of machines irrespective of the flow of soiled dishes. The recommendations include hot water supplied to dishwasher booster heaters.

Apartments

Hot-water requirements for both garden-type and high-rise apartments are for one- and two-bath apartments, showers, lavatories, kitchen sinks, dishwashers, clothes washers, and general cleaning

purposes. Clothes washers can be either in individual apartments or centrally located. These data apply to central water-heating systems only.

Elementary Schools

Hot-water requirements are for lavatories, cafeteria and kitchen use, and general cleaning purposes. When showers are used, their additional hot-water requirements should be added. The recommendations include hot water for dishwashers but not for extended school operation such as evening classes.

High Schools

Senior high schools, grades 9 or 10 through 12, require hot water for showers, lavatories, dishwashers, kitchens, and general cleaning. Junior high schools, grades 7 through 8 or 9, have requirements similar to those of the senior high schools. Junior high schools without showers follow the recommendations for elementary schools.

Requirements for high schools are based on daytime use. Recommendations do not take into account hot-water usage for additional activities such as night school. In such cases, the maximum hourly demand remains the same, but the maximum daily and the average daily usage increases, usually by the number of additional people using showers and, to a lesser extent, eating and washing facilities.

Additional Data

Fast Food Restaurants. Hot water is used for food preparation, cleanup, and rest rooms. Dish washing is usually not a significant load. In most facilities, peak usage occurs during the cleanup period, typically soon after opening and immediately before closing. Hot-water consumption varies significantly among individual facilities. Fast food restaurants typically consume 250 to 500 gallons per day (EPRI 1994).

Supermarkets. The trend in supermarket design is to incorporate food preparation and food service functions, substantially increasing the usage of hot water. Peak usage is usually associated with cleanup periods, often at night, with a total consumption of 300 to 1000 gallons per day (EPRI 1994).

Apartments. Table 7 differs from Table 6 in that it represents low-medium-high (LMH) guidelines rather than specific singular volumes. The values presented in Table 7 are based on monitored domestic hot water consumption found in the studies by Becker et al. (1991), Goldner (1994a, 1994b), and Goldner and Price (1996), and Thrasher and DeWerth (1994).

“Medium” is the overall average. “Low” is the lowest peak value. Such values are generally associated with apartment buildings having such occupant demographics as (1) all occupants working, (2) seniors, (3) couples with children, (4) middle income, or (5) higher population density. “High” is the maximum recurring value. These values are generally associated with (1) high percentage of children, (2) low income, (3) public assistance, or (4) no occupants working.

In applying these guidelines, the designer should note that a building may outlast its current use. This may be a reason to increase the design capacity for domestic hot water or allow for future enhancement of the service hot-water system. Building management practices, such as the explicit prohibition (in the lease) of apartment clothes washers or the existence of bath/kitchen hook-ups, should be

Table 7 Hot-Water Demand and Use Guidelines for Apartment Buildings (Gallons per Person)

Guideline	Maximum Hourly	Peak 15 Minutes	Maximum Daily	Average Daily
Low	3	1	20	14
Medium	5	2	49	30
High	9	3	90	54

factored into the design process. A diversity factor that lowers the probability of coincident consumption should also be used in larger buildings.

SIZING EXAMPLES

Figures 14 through 21 show the relationships between recovery and storage capacity for the various building categories. Any combination of storage and recovery rates that falls on the proper curve will satisfy the building requirements. Using the minimum recovery rate and the maximum storage capacity on the curves yields the smallest hot-water capacity capable of satisfying the building requirement. The higher the recovery rate, the greater the 24 h heating capacity and the smaller the storage capacity required.

These curves can be used to select recovery and storage requirements to accommodate water heaters that have fixed storage or recovery rates. Where hot-water demands are not coincident with peak electric, steam, or gas demands, greater heater inputs can be selected if they do not create additional energy system demands, and the corresponding storage tank size can be selected from the curves.

Ratings of gas-fired water-heating equipment are based on sea-level operation and apply for operation at elevations up to 2000 ft. For operation at elevations above 2000 ft, and in the absence of specific recommendations from the local authority, equipment ratings should be reduced at the rate of 4% for each 1000 ft above sea level before selecting appropriately sized equipment.

Recovery rates in Figures 14 through 21 represent the actual hot-water required without considering system heat losses. Heat losses from storage tanks and recirculating hot-water piping should be calculated and added to the recovery rates shown. Storage tanks and hot-water piping must be insulated.

The storage capacities shown are net usable requirements. Assuming that 60 to 80% of the hot water in a storage tank is usable, the actual storage tank size should be increased by 25 to 66% to compensate for unusable hot water.

Examples

In the following examples, results are often rounded to the accuracy appropriate for the assumptions made.

Example 1. Determine the required water heater size for a 300-student women’s dormitory for the following criteria:

- Storage with minimum recovery rate
- Storage with recovery rate of 2.5 gph per student
- With the additional requirement for a cafeteria to serve a maximum of 300 meals per hour for minimum recovery rate, combined with item *a*; and for a recovery rate of 1.0 gph per maximum meals per hour, combined with item *b*

Solution:

a. The minimum recovery rate from Figure 14 for women’s dormitories is 1.1 gph per student, or 330 gph total. At this rate, storage required is 12 gal per student or 3600 gal total. On a 70% net usable basis, the necessary tank size is $3600/0.7 = 5150$ gal.

b. The same curve shows 5 gal storage per student at 2.5 gph recovery, or $300 \times 5 = 1500$ gal storage with recovery of $300 \times 2.5 = 750$ gph. The tank size will be $1500/0.7 = 2150$ gal.

c. The requirements for a cafeteria can be determined from Figure 18 and added to those for the dormitory. For the case of minimum recovery rate, the cafeteria (Type A) requires $300 \times 0.45 = 135$ gph recovery rate and $300 \times 7/0.7 = 3000$ gal of additional storage. The entire building then requires $330 + 135 = 465$ gph recovery and $5150 + 3000 = 8150$ gal of storage.

With 1 gph recovery at the maximum hourly meal output, the recovery required is 300 gph, with $300 \times 2.0/0.7 = 860$ gal of additional storage. Combining this with item *b*, the entire building requires $750 + 300 = 1050$ gph recovery and $2150 + 860 = 3010$ gal of storage.

Note: Recovery capacities shown are for heating water only. Additional capacity must be added to offset the system heat losses.

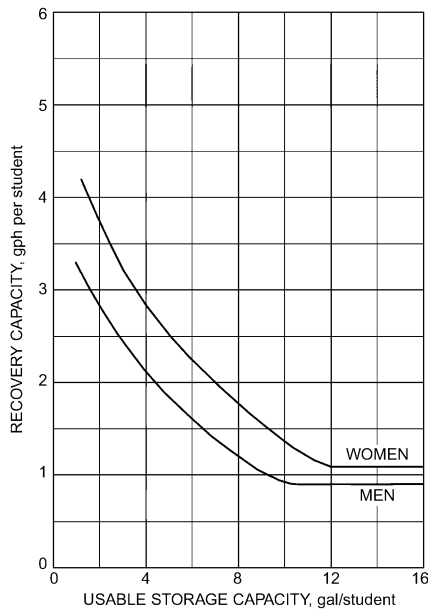

Fig. 14 Dormitories

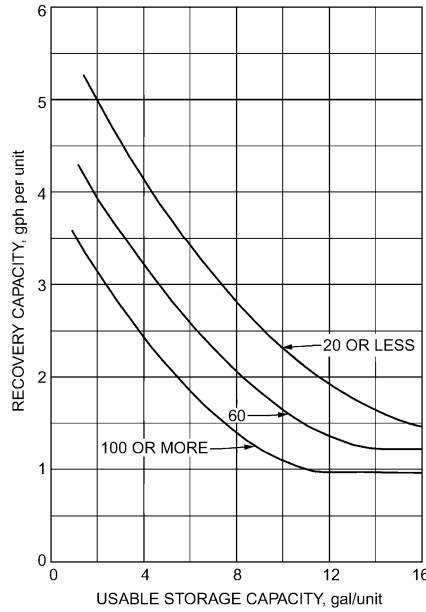

Fig. 15 Motels

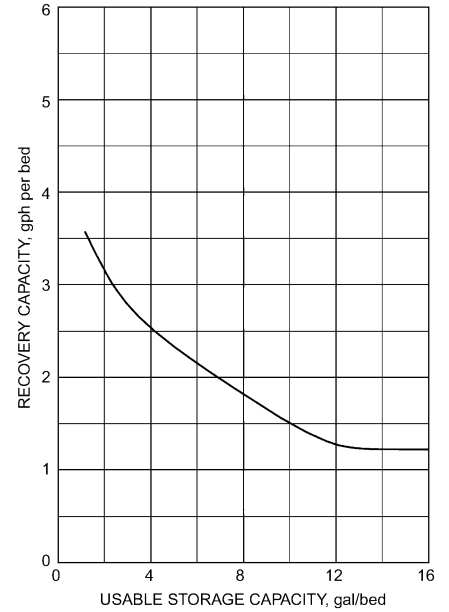

Fig. 16 Nursing Homes

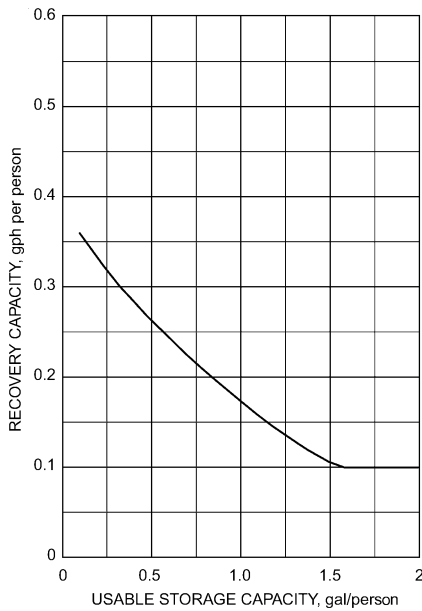

Fig. 17 Office Buildings

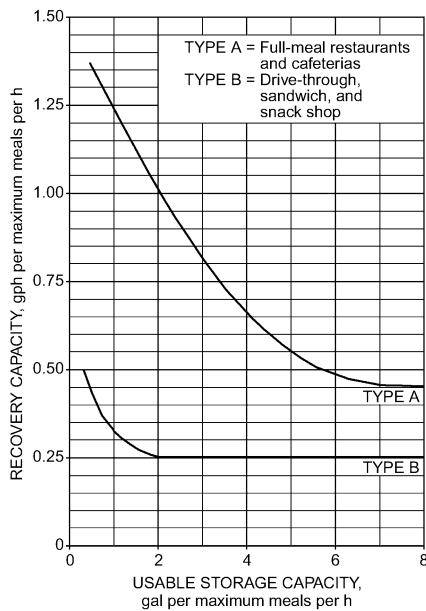

Fig. 18 Food Service

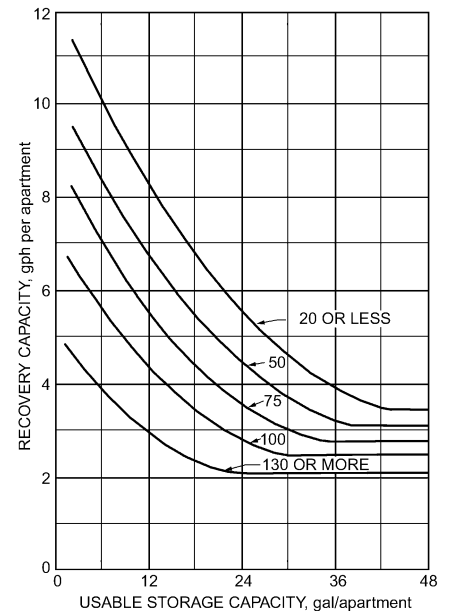

Fig. 19 Apartments

Example 2. Determine the water-heater size and monthly hot-water consumption for an office building to be occupied by 300 people under the following conditions:

- Storage with minimum recovery rate
- Storage with 1.0 gal per person storage
- Additional minimum recovery rate requirement for a luncheonette open 5 days a week, serving a maximum of 100 meals per hour and an average of 200 meals per day
- Monthly hot-water consumption

Solution:

a. With minimum recovery rate of 0.1 gph per person from [Figure 17](#), 30 gph recovery is required; the storage is 1.6 gal per person, or $300 \times 1.6 = 480$ gal. If 70% of the hot water is usable, the tank size will be $480/0.7 = 690$ gal.

b. The curve also shows 1.0 gal storage per person at 0.175 gph per person recovery, or $300 \times 0.175 = 52.5$ gph. The tank size will be $300/0.7 = 430$ gal.

c. The hot-water requirements for a luncheonette (Type B) are contained in [Figure 18](#). With a minimum recovery capacity of 0.25 gph per maximum meals per hour, 100 meals per hour would require 25 gph recovery, while the storage would be 2.0 gal per maximum meals per hour, or $100 \times 2.0/0.7 = 290$ gal storage. The combined requirements with item a would then be 55 gph recovery and 980 gal storage.

Combined with item b, the requirement is 77.5 gph recovery and 720 gal storage.

d. Average day values are found in [Table 6](#). The office building will consume an average of 1.0 gal per person per day \times 30 days per month \times 300 people = 9000 gal per month and the luncheonette will

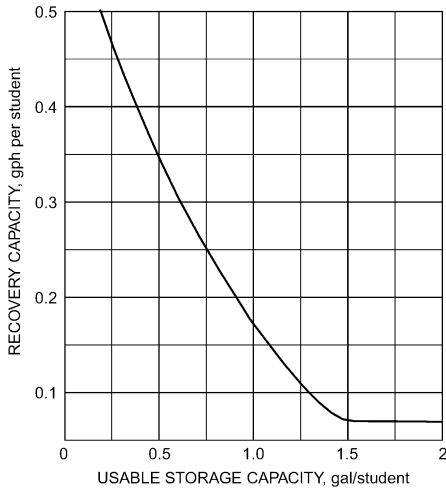

Fig. 20 Elementary Schools

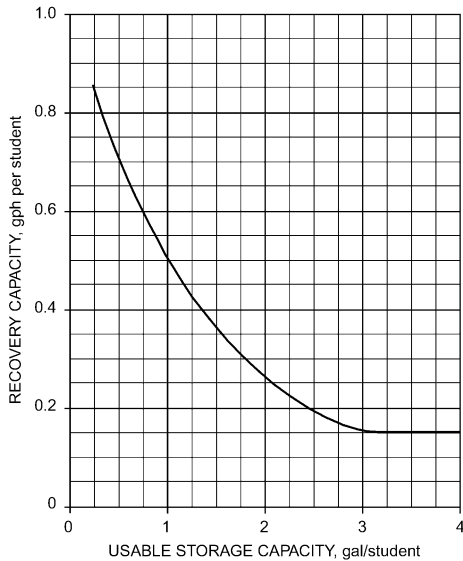

Fig. 21 High Schools

consume 0.7 gal per meal \times 200 meals per day \times 22 days per month = 3100 gal per month, for a total of 12,100 gal per month.

Note: Recovery capacities shown are for heating water only. Additional capacity must be added to offset the system heat losses.

Example 3. Determine the water heater size for a 200-unit apartment house under the following conditions:

- a. Storage with minimum recovery rate
- b. Storage with 4 gph per apartment recovery rate
- c. Storage for each of two 100-unit wings
 - 1. Minimum recovery rate
 - 2. Recovery rate of 4 gph per apartment

Solution:

a. The minimum recovery rate, from Figure 19, for apartment buildings with 200 apartments is 2.1 gph per apartment, or a total of 420 gph. The storage required is 24 gal per apartment, or 4800 gal. If 70% of this hot water is usable, the necessary tank size is $4800/0.7 = 6900$ gal.

b. The same curve shows 5 gal storage per apartment at a recovery rate of 4 gph per apartment, or $200 \times 4 = 800$ gph. The tank size will be $200 \times 5/0.7 = 1400$ gal.

c. Solution for a 200-unit apartment house having two wings, each with its own hot-water system.

1. With minimum recovery rate of 2.5 gph per apartment (see Figure 19), a 250 gph recovery is required, while the necessary storage is 28 gal per apartment, or $100 \times 28 = 2800$ gal. The required tank size is $2800/0.7 = 4000$ gal for each wing.

2. The curve shows that for a recovery rate of 4 gph per apartment the storage would be 14 gal per apartment, or $100 \times 14 = 1400$ gal, with recovery of $100 \times 4 = 400$ gph. The necessary tank size is $1400/0.7 = 2000$ gal in each wing.

Note: Recovery capacities shown are for heating water only. Additional capacity must be added to offset the system heat loss.

Example 4. Determine the water-heater size and monthly hot-water consumption for a 2000-student high school under the following conditions:

- a. Storage with minimum recovery rate
- b. Storage with 4000 gal maximum storage capacity
- c. Monthly hot-water consumption

Solution:

a. With the minimum recovery rate of 0.15 gph per student (from Figure 21) for high schools, 300 gph recovery is required. The storage required is 3.0 gal per student, or $2000 \times 3.0 = 6000$ gal. If 70% of the hot water is usable, the tank size is $6000/0.7 = 8600$ gal.

b. The net storage capacity will be $0.7 \times 4000 = 2800$ gal, or 1.4 gal per student. From the curve, a recovery capacity of 0.37 gph per student or $2000 \times 0.37 = 740$ gph is required.

c. From Table 6, monthly hot-water consumption is 2000 students \times 1.8 gal per student per day \times 22 days = 79,000 gal.

Note: Recovery capacities shown are for heating water only. Additional capacity must be added to offset the system heat loss.

Table 8 can be used to determine the size of water-heating equipment from the number of fixtures. To obtain the probable maximum demand, multiply the total quantity for the fixtures by the demand factor in line 19. The heater or coil should have a water heating capacity equal to this probable maximum demand. The storage tank should have a capacity equal to the probable maximum demand multiplied by the storage capacity factor in line 20.

Example 5. Determine heater and storage tank size for an apartment building from a number of fixtures.

Solution:

60 lavatories	\times	2 gph	=	120 gph
30 bathtubs	\times	20 gph	=	600 gph
30 showers	\times	30 gph	=	900 gph
60 kitchen sinks	\times	10 gph	=	600 gph
15 laundry tubs	\times	20 gph	=	300 gph
Possible maximum demand			=	2520 gph
Probable maximum demand	=	2520×0.30	=	756 gph
Heater or coil capacity			=	756 gph
Storage tank capacity	=	756×1.25	=	945 gal

Showers

In many housing installations such as motels, hotels, and dormitories, the peak hot-water load is usually from the use of showers. Tables 8 and 13 indicate the probable hourly hot-water demand and the recommended demand and storage capacity factors for various types of buildings. Hotels could have a 3 to 4 h peak shower load. Motels require similar volumes of hot water, but the peak demand may last for only a 2 h period. In some types of housing, such as barracks, fraternity houses, and dormitories, all occupants may take showers within a very short period. In this case, it is best to find the peak load by determining the number of shower heads and the rate of flow per head; then estimate the length of time the shower will be on. It is estimated that the average shower time per individual is 7.5 min (Meier 1985).

The flow rate from a shower head varies depending on type, size, and water pressure. At 40 psi water pressure, available shower heads have nominal flow rates of blended hot and cold water from about 2.5 to 6 gpm. In multiple shower installations, flow control valves on shower heads are recommended because they reduce the flow

Table 8 Hot-Water Demand per Fixture for Various Types of Buildings
(Gallons of water per hour per fixture, calculated at a final temperature of 140°F)

	Apartment House	Club	Gymnasium	Hospital	Hotel	Industrial Plant	Office Building	Private Residence	School	YMCA
1. Basin, private lavatory	2	2	2	2	2	2	2	2	2	2
2. Basin, public lavatory	4	6	8	6	8	12	6	—	15	8
3. Bathtub ^c	20	20	30	20	20	—	—	20	—	30
4. Dishwasher ^a	15	50-150	—	50-150	50-200	20-100	—	15	20-100	20-100
5. Foot basin	3	3	12	3	3	12	—	3	3	12
6. Kitchen sink	10	20	—	20	30	20	20	10	20	20
7. Laundry, stationary tub	20	28	—	28	28	—	—	20	—	28
8. Pantry sink	5	10	—	10	10	—	10	5	10	10
9. Shower	30	150	225	75	75	225	30	30	225	225
10. Service sink	20	20	—	20	30	20	20	15	20	20
11. Hydrotherapeutic shower				400						
12. Hubbard bath				600						
13. Leg bath				100						
14. Arm bath				35						
15. Sitz bath				30						
16. Continuous-flow bath				165						
17. Circular wash sink				20	20	30	20		30	
18. Semicircular wash sink				10	10	15	10		15	
19. DEMAND FACTOR	0.30	0.30	0.40	0.25	0.25	0.40	0.30	0.30	0.40	0.40
20. STORAGE CAPACITY FACTOR ^b	1.25	0.90	1.00	0.60	0.80	1.00	2.00	0.70	1.00	1.00

^aDishwasher requirements should be taken from this table or from manufacturers' data for the model to be used, if this is known.

^bRatio of storage tank capacity to probable maximum demand/h. Storage capacity may be reduced where an unlimited supply of steam is available from a central street steam system or large boiler plant.

^cWhirlpool baths require specific consideration based on their capacity. They are not included in the bathtub category.

rate and maintain it regardless of fluctuations in water pressure. Flow can usually be reduced to 50% of the manufacturer's maximum flow rating without adversely affecting the spray pattern of the shower head. Flow control valves are commonly available with capacities from 1.5 to 4.0 gpm.

If the manufacturer's flow rate for a shower head is not available and no flow control valve is used, the following average flow rates may serve as a guide for sizing the water heater:

Small shower head	2.5 gpm
Medium shower head	4.5 gpm
Large shower head	6 gpm

Food Service

In restaurants, bacteria are usually killed by rinsing washed dishes with 180 to 195°F water for several seconds. In addition, an ample supply of general-purpose hot water, usually 140 to 150°F, is required for the wash cycle of dishwashers. Although a water temperature of 140°F is reasonable for dish washing in private dwellings, in public places, the NSF or local health departments require 180 to 195°F water in the rinsing cycle. However, the NSF allows a lower temperature when certain types of machines and chemicals are used. The two-temperature hot-water requirements of food service establishments present special problems. The lower temperature water is distributed for general use, but the 180°F water should be confined to the equipment requiring it and should be obtained by boosting the temperature. It would be dangerous to distribute 180°F water for general use. ANSI/NSF 3-2001 covers the design of dishwashers and water heaters used by restaurants. The American Gas Association (Dunn et al. 1959) has published a recommended procedure for sizing water heaters for restaurants that consists of determining the following:

- Types and sizes of dishwashers used (manufacturers' data should be consulted to determine the initial fill requirements of the wash tanks)
- Required quantity of general-purpose hot water
- Duration of peak hot-water demand period
- Inlet water temperature

- Type and capacity of existing water heating system
- Type of water heating system desired

After the quantity of hot water withdrawn from the storage tank each hour has been taken into account, the following equation may be used to size the required heater(s). The general-purpose and 180 to 195°F water requirements are determined from [Tables 9](#) and [10](#).

$$q_i = Q_h c_p \rho \Delta t / \eta \tag{6}$$

where

- q_i = heater input, Btu/h
- Q_h = flow rate, gph
- c_p = specific heat of water = 1.00 Btu/lb·°F
- ρ = density of water = 8.33 lb/gal
- Δt = temperature rise, °F
- η = heater efficiency

To determine the quantity of usable hot water from storage, the duration of consecutive peak demand must be estimated. This peak usually coincides with the dishwashing period during and after the main meal and may last from 1 to 4 h. Any hour in which the dishwasher is used at 70% or more of capacity should be considered a peak hour. If the peak demand lasts for 4 h or more, the value of a storage tank is reduced, unless especially large tanks are used. Some storage capacity is desirable to meet momentary high draws.

NSF *Standard 5* recommendations for hot-water rinse demand are based on 100% operating capacity of the machines, as are the data provided in [Table 9](#). NSF *Standard 5* states that 70% of operating rinse capacity is all that is normally attained, except for rackless-type conveyor machines.

Examples 6, 7, and 8 demonstrate the use of Equation (6) in conjunction with [Tables 9](#) and [10](#).

Example 6. Determine the hot-water demand for water heating in a cafeteria kitchen with one vegetable sink, five lavatories, one prescrapper, one utensil washer, and one two-tank conveyor dishwasher (dishes inclined) with makeup device. The initial fill requirement for the tank of the utensil washer is 85 gph at 140°F. The initial fill requirement for the dishwasher is 20 gph for each tank, or a total of 40 gph, at 140°F. The maximum

Table 9 NSF Final Rinse Water Requirement for Dishwashers^a

Type and Size of Dishwasher	Flow Rate, gpm	180 to 195°F Hot-Water Requirements	
		Heaters Without Internal Storage, ^b gph	Heaters with Internal Storage to Meet Flow Demand, ^c gph
Door type:			
16 × 16 in.	6.94	416	69
18 × 18 in.	8.67	520	87
20 × 20 in.	10.4	624	104
Undercounter	5	300	70
Conveyor type:			
Single tank	6.94	416	416
Multiple tank (dishes flat)	5.78	347	347
Multiple tank (dishes inclined)	4.62	277	277
Silver washers	7	420	45
Utensil washers	8	480	75
Makeup water requirements	2.31	139	139

Note: Values are extracted from a previous version of ANSI/NSF Standard 3. The current version of ANSI/NSF Standard 3-2001 is a performance-based standard that no longer lists minimum flow rates.

^aFlow pressure at dishwashers is assumed to be 20 psig.

^bBased on the flow rate in gpm.

^cBased on dishwasher operation at 100% of mechanical capacity.

Table 10 General-Purpose Hot-Water (140°F) Requirement for Various Kitchens Uses^{a,b}

Equipment	gph
Vegetable sink	45
Single pot sink	30
Double pot sink	60
Triple pot sink	90
Prescrapper (open type)	180
Preflush (hand-operated)	45
Preflush (closed type)	240
Recirculating preflush	40
Bar sink	30
Lavatories (each)	5

Source: Dunn et al. (1959).

^aSupply water pressure at equipment is assumed to be 20 psig.

^bDishwasher operation at 100% of mechanical capacity.

period of consecutive operation of the dishwasher at or above 70% capacity is assumed to be 2 h. The supply water temperature is 60°F.

Solution: The required quantities of general purpose (140°F) and rinse (180°F) water for the equipment, from Tables 9 and 10 and given values, are shown in the following tabulation:

Item	Quantity Required at 140°F, gph	Quantity Required at 180°F, gph
Vegetable sink	45	—
Lavatories (5)	25	—
Prescrapper	180	—
Dishwasher	—	277
Initial tank fill	40	—
Makeup water	—	139
Utensil washer	—	75
Initial tank fill	85	—
Total requirements	375	491

The total consumption of 140°F water is 375 gph. The total consumption at 180°F depends on the type of heater to be used. For a heater that has enough internal storage capacity to meet the flow demand, the total consumption of 180°F water is (277 + 139 + 75) =

491 gph based on the requirements taken from Table 9, or approximately 350 gph (0.70 × 491 = 344 gph). For an instantaneous heater without internal storage capacity, the total quantity of 180°F water consumed must be based on the flow demand. From Table 9, the quantity required for the dishwasher is 277 gph; for the makeup, 139 gph; and for the utensil washer, 480 gph. The total consumption of 180°F water is 277 + 139 + 480 = 896 gph, or approximately 900 gph.

Example 7. Determine fuel input requirements (assume 75% heater efficiency) for heating water in the cafeteria kitchen described in Example 6, by the following systems, which are among many possible solutions:

a. Separate, self-contained, storage-type heaters

b. Single instantaneous-type heater having no internal storage, to supply both 180°F and 140°F water through a mixing valve

c. Separate instantaneous-type heaters having no internal storage

Solution:

a. The temperature rise for 140°F water is 140 – 60 = 80°F. From Equation (6), the fuel input required to produce 375 gph of 140°F water with an 80°F temperature rise at 75% efficiency is about 333,000 Btu/h. One or more heaters may be selected to meet this total requirement.

From Equation (6), the fuel input required to produce 491 gph of 180°F water with a temperature rise of 180 – 60 = 120°F at 75% efficiency is 654,000 Btu/h. One or more heaters with this total requirement may be selected from manufacturers' catalogs.

b. The correct sizing of instantaneous-type heaters depends on the flow rate of the 180°F rinse water. From Example 6, the consumption of 180°F water based on the flow rate is 900 gph; consumption of 140°F water is 375 gph.

Fuel input required to produce 900 gph (277 + 480 + 139) of 180°F water with a 120°F temperature rise is 1,200,000 Btu/h. Fuel input to produce 375 gph of 140°F water with a temperature rise of 80°F is 333,000 Btu/h. Total heater requirement is 1,200,000 + 333,000 = 1,533,000 Btu/h. One or more heaters meeting this total input requirement can be selected from manufacturers' catalogs.

c. Fuel input required to produce 140°F water is the same as for Solution *b*, 333,000 Btu/h. One or more heaters meeting this total requirement can be selected.

Fuel input required to produce 180°F water is also the same as in Solution *b*, 1,200,000 Btu/h. One or more heaters meeting this total requirement can be selected.

Example 8. A luncheonette has purchased a door-type dishwasher that will handle 16 by 16 in. racks. The existing hot-water system is capable of supplying the necessary 140°F water to meet all requirements for general-purpose use and for the booster heater that is to be installed. Determine the size of the following booster heaters operating at 75% thermal efficiency required to heat 140°F water to provide sufficient 180°F rinse water for the dishwasher:

a. Booster heater with no storage capacity

b. Booster heater with enough storage capacity to meet flow demand

Solution:

a. Because the heater is the instantaneous type, it must be sized to meet the 180°F water demand at a rated flow. From Table 9, this rated flow is 6.94 gpm, or 416 gph. From Equation (6), the required fuel input with a 40°F temperature rise is 185,000 Btu/h. A heater meeting this input requirement can be selected from manufacturers' catalogs.

b. In designing a system with a booster heater having storage capacity, the dishwasher's hourly flow demand can be used instead of the flow demand used in Solution *a*. The flow demand from Table 9 is 69 gph when the dishwasher is operating at 100% mechanical capacity. From Equation (6), with a 40°F temperature rise, the fuel input required is 30,700 Btu/h. A booster heater with this input can be selected from manufacturers' catalogs.

Estimating Procedure. Hot-water requirements for kitchens are sometimes estimated on the basis of the number of meals served (assuming eight dishes per meal). Demand for 180°F water for a dishwasher is

$$D_1 = C_1 N / \theta \quad (7)$$

where

D_1 = water for dishwasher, gph

N = number of meals served

θ = hours of service
 C_1 = 0.8 for single-tank dishwasher
 = 0.5 for two-tank dishwasher

Demand for water for a sink with gas burners is

$$D_2 = C_2V \tag{8}$$

where

D_2 = water for sink, gph
 C_2 = 3
 V = sink capacity (15 in. depth), gal

Demand for general-purpose hot water at 140°F is

$$D_3 = C_3N/(\theta + 2) \tag{9}$$

where

D_3 = general-purpose water, gph
 C_3 = 1.2

Total demand is

$$D = D_1 + D_2 + D_3$$

For soda fountains and luncheonettes, use 75% of the total demand. For hotel meals or other elaborate meals, use 125%.

Schools

Service water heating in schools is needed for janitorial work, lavatories, cafeterias, shower rooms, and sometimes swimming pools.

Hot-water used in cafeterias is about 70% of that usually required in a commercial restaurant serving adults and can be estimated by the method used for restaurants. Where NSF sizing is required, follow *Standard 5*.

Shower and food service loads are not ordinarily concurrent. Each should be determined separately, and the larger load should determine the size of the water heater(s) and the tank. Provision must be made to supply 180°F sanitizing rinse. The booster must be sized according to the temperature of the supply water. If feasible, the same water can be used for both needs. If the distance between the two points of need is great, a separate water heater should be used.

A separate heater system for swimming pools can be sized as outlined in the section on Swimming Pools/Health Clubs.

Domestic Coin-Operated Laundries

Small domestic machines in coin laundries or apartment house laundry rooms have a wide range of draw rates and cycle times. Domestic machines provide a wash water temperature (normal) as low as 120°F. Some manufacturers recommend a temperature of 160°F; however, the average appears to be 140°F. Hot-water sizing calculations must ensure a supply to both the instantaneous draw requirements of a number of machines filling at one time and the average hourly requirements.

The number of machines that will be drawing at any one time varies widely; the percentage is usually higher in smaller installations. One or two customers starting several machines at about the same time has a much sharper effect in a laundry with 15 or 20 machines than in one with 40 machines. Simultaneous draw may be estimated as follows:

1 to 11 machines	100% of possible draw
12 to 24 machines	80% of possible draw
25 to 35 machines	60% of possible draw
36 to 45 machines	50% of possible draw

Possible peak draw can be calculated from

$$F = NPV_f/T \tag{10}$$

where

F = peak draw, gpm
 N = number of washers installed

P = number of washers drawing hot water divided by N
 V_f = quantity of hot water supplied to machine during hot wash fill, gal
 T = wash fill period, min

Recovery rate can be calculated from

$$R = 60NPV_f/(\theta + 10) \tag{11}$$

where

R = total hot water (machines adjusted to hottest water setting), gph
 θ = actual machine cycle time, min

Note: $(\theta + 10)$ is the cycle time plus 10 min for loading and unloading.

Commercial Laundries

Commercial laundries generally use a storage water heater. The water may be softened to reduce soap use and improve quality. The trend is toward installing high-capacity washer-extractor wash wheels, resulting in high peak demand.

Sizing Data. Laundries can normally be divided into five categories. The required hot water is determined by the weight of the material processed. Average hot-water requirements at 180°F are

Institutional	2 gal/lb·h
Commercial	2 gal/lb·h
Linen supply	2.5 gal/lb·h
Industrial	2.5 gal/lb·h
Diaper	2.5 gal/lb·h

Total weight of the material times these values give the average hourly hot-water requirements. The designer must consider peak requirements; for example, a 600 lb machine may have a 20 gpm average requirement, but the peak requirement could be 350 gpm.

In a multiple-machine operation, it is not reasonable to fill all machines at the momentary peak rate. Diversity factors can be estimated by using 1.0 of the largest machine plus the following balance:

	Total number of machines				
	2	3 to 5	6 to 8	9 to 11	12 and over
1.0 +	0.6	0.45	0.4	0.35	0.3

For example, four machines would have a diversity factor of $1.0 + 0.45 = 1.45$.

Types of Systems. Service water-heating systems for laundries are pressurized or vented. The pressurized system uses city water pressure, and the full peak flow rates are received by the softeners, reclaimers, condensate cooler, water heater, and lines to the wash wheels. The flow surges and stops at each operation in the cycle. A pressurized system depends on an adequate water service.

The vented system uses pumps from a vented (open) hot-water heater or tank to supply hot water. The tank's water level fluctuates from about 6 in. above the heating element to a point 12 in. from the top of the tank; this fluctuation defines the working volume. The level drops for each machine fill, and makeup water runs continuously at the average flow rate and water service pressure during the complete washing cycle. The tank is sized to have full working volume at the beginning of each cycle. Lines and softeners may be sized for the average flow rate from the water service to the tank, not the peak machine fill rate as with a closed, pressurized system.

The waste heat exchangers have a continuous flow across the heating surface at a low flow rate, with continuous heat reclamation from the wastewater and flash steam. Automatic flow-regulating valves on the inlet water manifold control this low flow rate. Rapid fill of machines increases production (i.e., more batches can be processed).

Heat Recovery. Commercial laundries are ideally suited for heat recovery because 135°F wastewater is discharged to the sewer. Fresh water can be conservatively preheated to within 15°F

of the wastewater temperature for the next operation in the wash cycle. Regions with an annual average temperature of 55°F can increase to 120°F the initial temperature of fresh water going into the hot-water heater. For each 1000 gph or 8330 lb per hour of water preheated 65°F (55 to 120°F), heat reclamation and associated energy savings is 540,000 Btu/h.

Flash steam from a condensate receiving tank is often wasted to the atmosphere. The heat in this flash steam can be reclaimed with a suitable heat exchanger. Makeup water to the heater can be preheated 10 to 20°F above the existing makeup temperature with the flash steam.

Swimming Pools/Health Clubs

The desirable temperature for swimming pools is 80°F. Most manufacturers of water heaters and boilers offer specialized models for pool heating; these include a pool temperature controller and a water bypass to prevent condensation. The water-heating system is usually installed prior to the return of treated water to the pool. A circulation rate to generate a change of water every 8 h for residential pools and 6 h for commercial pools is acceptable. An indirect heater, in which piping is embedded in the walls or floor of the pool, has the advantage of reduced corrosion, scaling, and condensation because pool water does not flow through the pipes. The disadvantage of this type of system is the high initial installation cost.

The installation should have a pool temperature control and a water pressure or flow safety switch. The temperature control should be installed at the inlet to the heater; the pressure or flow switch can be installed at either the inlet or outlet, depending on the manufacturer's instructions. It affords protection against inadequate water flow.

Sizing should be based on four considerations:

- Conduction through the pool walls
- Convection from the pool surface
- Radiation from the pool surface
- Evaporation from the pool surface

Except in aboveground pools and in rare cases where cold groundwater flows past the pool walls, conduction losses are small and can be ignored. Because convection losses depend on temperature differentials and wind speed, these losses can be greatly reduced by the installation of windbreaks such as hedges, solid fences, or buildings.

Radiation losses occur when the pool surface is subjected to temperature differentials; these frequently occur at night, when the sky temperature may be as much as 80°F below ambient air temperature. This usually occurs on clear, cool nights. During the daytime, however, an unshaded pool will receive a large amount of radiant energy, often as much as 100,000 Btu/h. These losses and gains may offset each other. An easy method of controlling nighttime radiation losses is to use a floating pool cover; this also substantially reduces evaporative losses.

Evaporative losses constitute the greatest heat loss from the pool (50 to 60% in most cases). If it is possible to cut evaporative losses drastically, the heating requirement of the pool may be cut by as much as 50%. A floating pool cover can accomplish this.

A pool heater with an input great enough to provide a heat-up time of 24 h would be the ideal solution. However, it may not be the most economical system for pools that are in continuous use during an extended swimming season. In this instance, a less expensive unit providing an extended heat-up period of as much as 48 h can be used. Pool water may be heated by several methods. Fuel-fired water heaters and boilers, electric boilers, tankless electric circulation water heaters, air-source heat pumps, and solar heaters have all been used successfully. Air-source heat pumps and solar heating systems would probably be used to

extend a swimming season rather than to allow intermittent use with rapid pickup.

The following equations provide some assistance in determining the area and volume of pools:

Elliptical

$$\text{Area} = 3.14AB$$

A = short radius

B = long radius

$$\text{Volume} = 7.5 \text{ gal/ft}^3 \times \text{Area} \times \text{Average Depth}$$

Kidney Shape

$$\text{Area} = 0.45L(A+B) \text{ (approximately)}$$

L = length

A = width at one end

B = width at other end

$$\text{Volume} = 7.5 \text{ gal/ft}^3 \times \text{Area} \times \text{Average Depth}$$

Oval (for circular, set $L = 0$)

$$\text{Area} = 3.14R^2 + LW$$

L = length of straight sides

W = width or $2R$

R = radius of ends

$$\text{Volume} = 7.5 \text{ gal/ft}^3 \times \text{Area} \times \text{Average Depth}$$

Rectangular

$$\text{Area} = LW$$

L = length

W = width

$$\text{Volume} = 7.5 \text{ gal/ft}^3 \times \text{Area} \times \text{Average Depth}$$

The following is an effective method for heating outside pools. Additional equations can be found in [Chapter 4](#).

1. Obtain pool water capacity, in gallons.
2. Determine the desired heat pickup time in hours.
3. Determine the desired pool temperature—if not known, use 80°F.
4. Determine the average temperature of the coldest month of use.

The required heater output q_t can now be determined by the following equations:

$$q_1 = \rho c_p V(t_f - t_i) / \theta \quad (12)$$

where

q_1 = pool heat-up rate, Btu/h

ρ = density of water = 8.33 lb/gal

c_p = specific heat of water = 1.00 Btu/lb·°F

V = pool volume, gal

t_f = desired temperature (usually 80°F)

t_i = initial temperature of pool, °F

θ = pool heat-up time, h

$$q_2 = UA(t_p - t_a) \quad (13)$$

where

q_2 = heat loss from pool surface, Btu/h

U = surface heat transfer coefficient = 10.5 Btu/h·ft²·°F

A = pool surface area, ft²

t_p = pool temperature, °F

t_a = ambient temperature, °F

$$q_t = q_1 + q_2 \quad (14)$$

Notes: These heat loss equations assume a wind velocity of 3 to 5 mph. For pools sheltered by nearby fences, dense shrubbery, or buildings, an average wind velocity of less than 3.5 mph can be assumed. In this case, use 75% of the values calculated by Equation (13). For a velocity of 5 mph, multiply by 1.25; for 10 mph, multiply by 2.0.

Because Equation (13) applies to the coldest monthly temperatures, the calculated results may not be economical. Therefore, a value of one-half the surface loss plus the heat-up value yields a more viable heater output figure. The heater input then equals the output divided by the efficiency of the fuel source.

Whirlpools and Spas

Hot-water requirements for whirlpool baths and spas depend on temperature, fill rate, and total volume. Water may be stored separately at the desired temperature or, more commonly, regulated at the point of entry by blending. If rapid filling is desired, provide storage at least equal to the volume needed; fill rate can then be varied at will. An alternative is to establish a maximum fill rate and provide an instantaneous water heater that will handle the flow.

Industrial Plants

Hot water (potable) is used in industrial plants for cafeterias, showers, lavatories, gravity sprinkler tanks, and industrial processes. Employee cleanup load is usually heaviest and not concurrent with other uses. The other loads should be checked before sizing, however, to be certain that this is true.

The employee cleanup load consists of one or more of the following: (1) wash troughs or standard lavatories, (2) multiple wash sinks, and (3) showers. Hot-water requirements for employees using standard wash fixtures can be estimated at 1 gal of hot water for each clerical and light-industrial employee per work shift and 2 gal for each heavy-industrial worker.

For sizing purposes, the number of workers using multiple wash fountains is disregarded. Hot-water demand is based on full flow for the entire cleanup period. This usage over a 10 min period is indicated in Table 11. The shower load depends on the flow rate of the shower heads and their length of use. Table 11 may be used to estimate flow based on a 15 min period.

Water heaters used to prevent freezing in gravity sprinkler or water storage tanks should be part of a separate system. The load depends on tank heat loss, tank capacity, and winter design temperature.

Process hot water load must be determined separately. Volume and temperature vary with the specific process. If the process load occurs at the same time as the shower or cafeteria load, the system must be sized to reflect this total demand. Separate systems can also be used, depending on the size of the various loads and the distance between them.

Ready-Mix Concrete

In cold weather, ready-mix concrete plants need hot water to mix the concrete so that it will not be ruined by freezing before it sets. Operators prefer to keep the mix at about 70°F by adding hot water to the cold aggregate. Usually, water at about 150°F is considered proper for cold weather. If the water temperature is too high, some of the concrete will flash set.

Generally, 30 gal of hot water per cubic yard of concrete mix is used for sizing. To obtain the total hot water load, this number is multiplied by the number of trucks loaded each hour and the capacity of the trucks. The hot water is dumped into the mix as quickly as possible at each loading, so ample hot-water storage or large heat exchangers must be used. Table 12 shows a method of sizing water heaters for concrete plants.

Part of the heat may be obtained by heating the aggregate bin by circulating hot water through pipe coils in the walls or sides of the bin. If the aggregate is warmed in this manner, the temperature of the mixing water may be lower, and the aggregate will flow easily from the bins. When aggregate is not heated, it often freezes into chunks, which must be thawed before they will pass through the dump gates. If hot water is used for thawing, too much water accumulates in the aggregate, and control of the final product may vary beyond allowable limits. Therefore, jets of steam supplied by a

Table 11 Hot-Water Usage for Industrial Wash Fountains and Showers

Type	Multiple Wash Fountains		Showers	
	Gal of 140°F Water Required for 10 min Period ^a	Flow Rate, gpm	Gal of 140°F Water Required for 15 min Period ^b	Flow Rate, gpm
36 in. circular	40	3	29.0	
36 in. semicircular	22	4	39.0	
54 in. circular	66	5	48.7	
54 in. semicircular	40	6	58.0	

^aBased on 110°F wash water and 40°F cold water at average flow rates.

^bBased on 105°F shower water and 40°F cold water.

Table 12 Water Heater Sizing for Ready-Mix Concrete Plant
(Input and Storage Tank Capacity to Supply 150°F Water at 40°F Inlet Temperature)

Truck Capacity, yd ³	Water Heater Storage Tank Volume, gal	Time Interval Between Trucks, min*					
6	430	458	612	785	1375	1830	2760
7.5	490	527	700	900	1580	2100	3150
9	560	596	792	1020	1790	2380	3580
11	640	687	915	1175	2060	2740	4120

*This table assumes 10 min loading time for each truck. Thus, for a 50 min interval between trucks, it is assumed that 1 truck/h is served. For 0 min between trucks, it is assumed that one truck loads immediately after the truck ahead has pulled away. Thus, 6 trucks/h are served.

It also assumes each truck carries a 120 gal storage tank of hot water for washing down at the end of dumping the load. This hot water is drawn from the storage tank and must be added to the total hot-water demands. This has been included in the table.

small boiler and directed on the large chunks are often used for thawing.

SIZING INSTANTANEOUS AND SEMI-INSTANTANEOUS WATER HEATERS

The methods for sizing storage water-heating equipment should not be used for instantaneous and semi-instantaneous heaters. The following is based on the Hunter (1941) method for sizing hot- and cold-water piping, with diversity factors applied for hot water and various building types.

Fixture units (Table 13) are assigned to each fixture using hot water and totalled. Maximum hot-water demand is obtained from Figure 22 or Figure 23 by matching total fixture units to the curve for the type of building. Special consideration should be given to applications involving periodic use of shower banks, process equipment, laundry machines, etc., as may occur in field houses, gymnasiums, factories, hospitals, and other facilities. Because these applications could have all equipment on at the same time, total hot-water capacity should be determined and added to the maximum hot-water demand from the modified Hunter curves. Use the following equation to determine the total hot-water capacity needed for these applications when final water temperatures are lower than that of the water heater:

$$\frac{B - C}{H - C} \times \left(\text{Total water flow from all shower bank heads, gpm} \right) = \text{Hot water needed, gpm}$$

where

- B = blended water temperature out of fixture
- H = hot-water temperature to fixture
- C = cold-water temperature to fixture

The heater can then be selected for the total demand and total temperature rise required. For critical applications such as hospitals, multiple heaters with 100% standby are recommended. Consider multiple heaters for buildings in which continuity of service is important. The minimum recommended size for semi-instantaneous heaters is 10 gpm, except for restaurants, for which it is 15 gpm.

Table 13 Hot-Water Demand in Fixture Units (140°F Water)

	Apartments	Club	Gymnasium	Hospital	Hotels and Dormitories	Industrial Plant	Office Building	School	YMCA
Basin, private lavatory	0.75	0.75	0.75	0.75	0.75	0.75	0.75	0.75	0.75
Basin, public lavatory	—	1	1	1	1	1	1	1	1
Bathtub	1.5	1.5	—	1.5	1.5	—	—	—	—
Dishwasher*	1.5	Five fixture units per 250 seating capacity							
Therapeutic bath	—	—	—	5	—	—	—	—	—
Kitchen sink	0.75	1.5	—	3	1.5	3	—	0.75	3
Pantry sink	—	2.5	—	2.5	2.5	—	—	2.5	2.5
Service sink	1.5	2.5	—	2.5	2.5	2.5	2.5	2.5	2.5
Shower	1.5	1.5	1.5	1.5	1.5	3.5	—	1.5	1.5
Circular wash fountain	—	2.5	2.5	2.5	—	4	—	2.5	2.5
Semicircular wash fountain	—	1.5	1.5	1.5	—	3	—	1.5	1.5

*See Water-Heating Terminology section for definition of fixture unit.

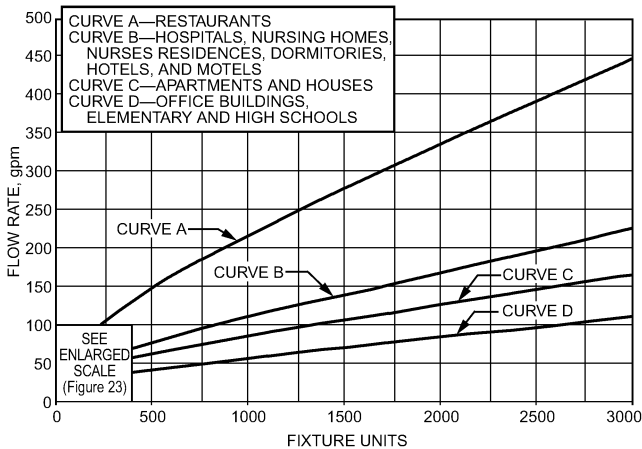

Fig. 22 Modified Hunter Curve for Calculating Hot Water Flow Rate

When the flow for a system is not easily determined, the heater may be sized for the full flow of the piping system at a maximum speed of 600 fpm. Heaters with low flows must be sized carefully, and care should be taken in the estimation of diversity factors. Unusual hot-water requirements should be analyzed to determine whether additional capacity is required. One example is a dormitory in a military school, where all showers and lavatories are used simultaneously when students return from a drill. In this case, the heater and piping should be sized for the full flow of the system.

Whereas the fixture count method bases heater size of the diversified system on hot water flow, hot-water piping should be sized for the full flow to the fixtures. Recirculating hot-water systems are adaptable to instantaneous heaters.

To make preliminary estimates of hot-water demand when the fixture count is not known, use [Table 14](#) with [Figure 22](#) or [Figure 23](#). The result will usually be higher than the demand determined from the actual fixture count. Actual heater size should be determined from [Table 13](#). Hot-water consumption over time can be assumed to be the same as that in the section on Hot-Water Requirements and Storage Equipment Sizing.

Example 9. A 600-student elementary school has the following fixture count: 60 public lavatories, 6 service sinks, 4 kitchen sinks, 6 showers, and 1 dishwasher at 8 gpm. Determine the hot-water flow rate for sizing a semi-instantaneous heater based on the following:

- Estimated number of fixture units
- Actual fixture count

Solution:

- Use [Table 14](#) to find the estimated fixture count: 600 students × 0.3 fixture units per student = 180 fixture units. As showers are not included,

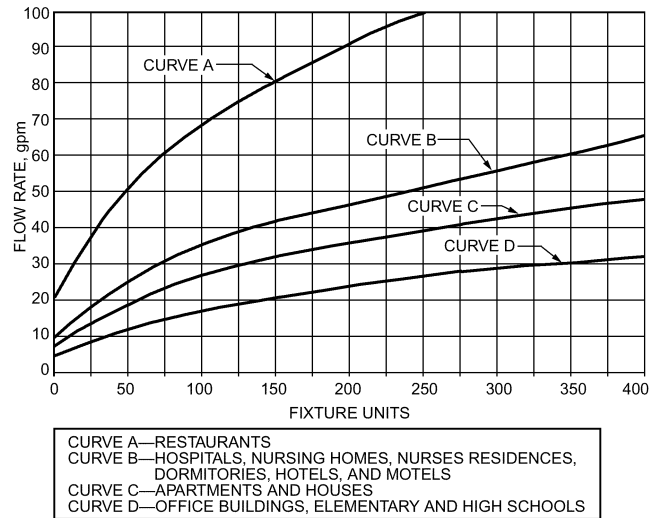

Fig. 23 Enlarged Section of Figure 22 (Modified Hunter Curve)

Table 14 Preliminary Hot-Water Demand Estimate

Type of Building	Fixture Units
Hospital or nursing home	2.50 per bed
Hotel or motel	2.50 per room
Office building	0.15 per person
Elementary school	0.30 per student*
Junior and senior high school	0.30 per student*
Apartment house	3.00 per apartment

*Plus shower load (in fixture units).

[Table 13](#) shows 1.5 fixture units per shower × 6 showers = 9 additional fixture units. The basic flow is determined from curve D of [Figure 23](#), which shows that the total flow for 189 fixture units is 23 gpm.

b. To size the unit based on actual fixture count and [Table 1](#), the calculation is as follows:

60 public lavatories	×	1.0	FU	=	60	FU
6 service sinks	×	2.5	FU	=	15	FU
4 kitchen sinks	×	0.75	FU	=	3	FU
6 showers	×	1.5	FU	=	9	FU
Subtotal					87	FU

At 87 fixture units, curve D of [Figure 23](#) shows 16 gpm, to which must be added the dishwasher requirement of 8 gpm. Thus, the total flow is 24 gpm.

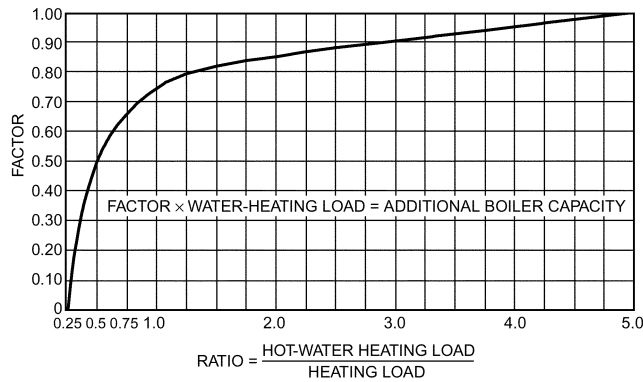

Fig. 24 Sizing Factor for Combination Heating and Water-Heating Boilers

Comparing the flow based on actual fixture count to that obtained from the preliminary estimate shows the preliminary estimate to be slightly lower in this case. It is possible that the preliminary estimate could have been as much as twice the final fixture count. To prevent such oversizing of equipment, use the actual fixture count method to select the unit.

SIZING REFRIGERANT-BASED WATER HEATERS

Refrigerant-based water heaters such as heat pump water heaters and refrigeration heat-reclaim systems cannot be sized like conventional systems to meet peak loads. The seasonal and instantaneous efficiency and output of these systems vary greatly with operating conditions. Computer software that performs detailed performance simulations taking these factors into account should be used for sizing and analysis. The capacities of these systems and any related supplemental water-heating equipment should be selected to achieve a high average daily run time and the lowest combination of operating and equipment cost. For heat pump water heaters, the adequacy of the heat source and the potential effect of the cooling output must be addressed.

BOILERS FOR INDIRECT WATER HEATING

When service water is heated indirectly by a space heating boiler, [Figure 24](#) may be used to determine the additional boiler capacity required to meet the recovery demands of the domestic water heating load. Indirect heaters include immersion coils in boilers as well as heat exchangers with space-heating media.

Because the boiler capacity must meet not only the water supply requirement but also the space heating loads, [Figure 24](#) indicates the reduction of additional heat supply for water heating if the ratio of water-heating load to space-heating load is low. This reduction is possible because

- Maximum space-heating requirements do not occur at the time of day when the maximum peak hot-water demands occur.
- Space-heating requirements are based on the lowest outside design temperature, which may occur for only a few days of the total heating season.
- An additional heat supply or boiler capacity to compensate for pickup and radiation losses is usual. The pickup load cannot occur at the same time as the peak hot-water demand because the building must be brought to a comfortable temperature before the occupants will be using hot water.

The factor obtained from [Figure 24](#) is multiplied by the peak water heating load to obtain the additional boiler output capacity required.

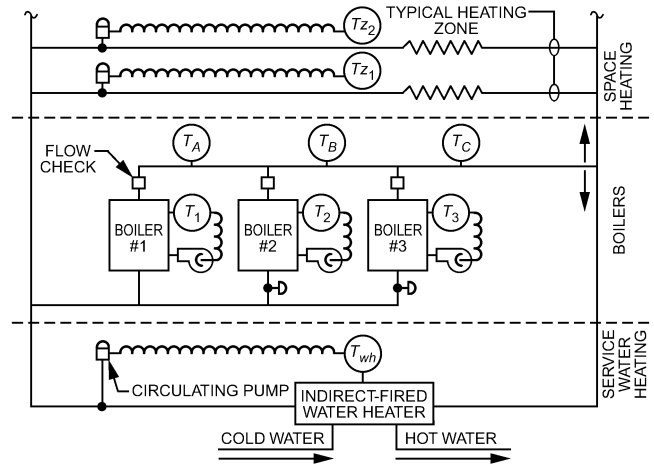

Fig. 25 Typical Modular Boiler for Combined Space and Water Heating

For reduced standby losses in summer and improved efficiency in winter, step-fired modular boilers may be used. Units not in operation cool down and reduce or eliminate jacket losses. The heated boiler water should not pass through an idle boiler. [Figure 25](#) shows a typical modular boiler combination space- and water-heating arrangement.

Typical Control Sequence

1. Any control zone or indirectly fired water heater thermostat starts its circulating pump and supplies power to boiler No. 1 control circuit.
2. If T_1 is not satisfied, burner is turned on, boiler cycles as long as any circulating pump is on.
3. If after 5 min T_A is not satisfied, V_1 opens and boiler No. 2 comes on line.
4. If after 5 min T_B is not satisfied, V_2 opens and boiler No. 3 comes on line.
5. If T_C is satisfied and two boilers or fewer are firing for a minimum of 10 min, V_2 closes.
6. If T_B is satisfied and only one boiler is firing for a minimum of 10 min, V_1 closes.
7. If all circulating pumps are off, boiler No. 1 shuts down.

The ASHRAE/IES *Standard 90* series discusses combination service water heating/space heating boilers and establishes restrictions on their use. The ASHRAE/IES *Standard 100* section on Service Water Heating also has information on this subject.

CODES AND STANDARDS

ANSI/AGA Z21.10.1-1998	Gas Water Heaters, Volume I: Storage Water Heaters with Input Ratings of 75,000 Btu per Hour or Less
ANSI/AGA Z21.10.3-1998	Gas Water Heaters, Volume III: Storage, with Input Ratings Above 75,000 Btu per Hour, Circulating, and Instantaneous Water Heaters
ANSI/NSF 3-2001	Pot, Pan, and Utensil Washers
ANSI Z21.56-1998	Gas-Fired Pool Heaters
ANSI Z21.22-1999	Relief Valves for Hot Water Supply Systems
ANSI Z21.87-1999	Automatic Gas Shutoff Devices for Hot Water Supply Systems
ASHRAE <i>Guideline</i> 12-2000	Minimizing the Risk of Legionellosis Associated with Building Water Systems
ASHRAE <i>Standard 90</i> series	
ASHRAE 100-1995	Energy Conservation in Existing Buildings
ASHRAE 118.1-1993	Methods of Testing for Rating Commercial Gas, Electric, and Oil Water Heaters
ASHRAE 118.2-1993	Methods of Testing for Rating Residential Water Heaters

ASME Boiler and Pressure Vessel Code	Section IV-98: Rules for Construction of Heating Boilers Section VIII D1-98: Rules for Construction of Pressure Vessels
HUD-FHA 4900.1	Minimum Property Standards for One- and Two-Family Living Units
NFPA 54-1999 (ANSI Z223.1-1996)	National Fuel Gas Code
NFPA 31-2001	Installation of Oil-Burning Equipment
NSF 5-2000	Water Heaters, Hot Water Supply Boilers, and Heat Recovery Equipment
UL 174-1996	Household Electric Storage Tank Water Heaters
UL 731-1995	Oil-Fired Unit Heaters
UL 1261-2001	Electric Water Heaters for Pools and Tubs
UL 1453-1995	Electric Booster and Commercial Storage Tank Water Heaters

REFERENCES

- Becker, B.R., W.H. Thrasher, and D.W. DeWerth. 1991. Comparison of collected and compiled existing data on service hot water use patterns in residential and commercial establishments. *ASHRAE Transactions* 97(2): 231-239.
- Ciesielki, C.A. et al. 1984. Role of stagnation and obstruction of water flow in isolation of *Legionella pneumophila* from hospital plumbing. *Applied and Environmental Microbiology* (November):984-987.
- DOE. 1990. Final rule regarding test procedures and energy conservation standards for water heaters. 10 CFR Part 430, *Federal Register* 55(201). U.S. Department of Energy.
- DOE. 1998. Uniform test method for measuring the energy consumption of water heaters. 10 CFR Part 430, Subpart B, Appendix E. U.S. Department of Energy.
- Dunn, T.Z., R.N. Spear, B.E. Twigg, and D. Williams. 1959. Water heating for commercial kitchens. *Air Conditioning, Heating and Ventilating* (May):70. Also published as a bulletin, *Enough hot water—hot enough*. American Gas Association (1959).
- EPRI. 1990. *Commercial heat pump water heaters applications handbook*. CU-6666. Electric Power Research Institute, Palo Alto, CA.
- EPRI. 1992. *Commercial water heating applications handbook*. TR-100212. Electric Power Research Institute, Palo Alto, CA.
- EPRI. 1994. *High-efficiency electric technology fact sheet: Commercial heat pump water heaters*. BR-103415. Electric Power Research Institute, Palo Alto, CA.
- GAMA. 1997. *Consumers' directory of certified efficiency rating for residential heating and water heating equipment*. Gas Appliance Manufacturers Association, Arlington, VA. April issue.
- Goldner, F.S. 1994a. Energy use and domestic hot water consumption: Final Report—Phase 1. *Report No. 94-19*. New York State Energy Research and Development Authority, Albany, NY.
- Goldner, F.S. 1994b. DHW system sizing criteria for multifamily buildings. *ASHRAE Transactions* 100(1):963-977.
- Goldner, F.S. and D.C. Price. 1996. DHW modeling: System sizing and selection criteria, Phase 2. *Interim Project Research Report #1*. New York State Energy Research and Development Authority, Albany.
- Hiller, C.C. 1998. New hot water consumption analysis and water-heating system sizing methodology. *ASHRAE Transactions* 104(1B):1864-1877.
- Hunter, R.B. 1941. Water distributing systems for buildings. National Bureau of Standards *Report BMS 79*.
- Kweller, E.R. 1992. Derivation of the combined annual efficiency of space/water heaters in ASHRAE 124-1991. *ASHRAE Transactions* 98(1):665-675.
- Manian, V.S. and W. Chackeris. 1974. Off peak domestic hot water systems for large apartment buildings. *ASHRAE Transactions* 80(1):147-165.
- Meier, A. 1985. Low-flow showerheads, family strife, and cold feet. *Home Energy*. Also available online at <http://homeenergy.org/archive/hem.dis.anl.gov/eehem/94/940702.html>.
- NFPA. 1996. National fuel gas code. *Standard 54*, also ANSI Z223.1. National Fire Protection Association, Quincy, MA.
- Perlman, M. and B. Mills. 1985. Development of residential hot water use patterns. *ASHRAE Transactions* 91(2A):657-679.
- Pietsch, J.A. and S.G. Talbert. 1989. Equipment sizing procedures for combination space-heating/water-heating systems. *ASHRAE Transactions* 95(2):250-258.
- Pietsch, J.A., S.G. Talbert, and S.H. Stanbouly. 1994. Annual cycling characteristics of components in gas-fired combination space/water systems. *ASHRAE Transactions* 100(1):923-934.
- Subherwal, B.R. 1986. Combination water-heating/space-heating appliance performance. *ASHRAE Transactions* 92(2B):415-432.
- Talbert, S.G., G.H. Stickford, D.C. Newman, and W.N. Stiegelmeier. 1986. The effect of hard water scale buildup and water treatment on residential water heater performance. *ASHRAE Transactions* 92(2B):433-447.
- Talbert, S.G., J.G. Murray, R.A. Borgeson, V.P. Kam, and J.A. Pietsch. 1992. Operating characteristics and annual efficiencies of combination space/water-heating systems. *ASHRAE Transactions* 98(1):655-664.
- Toaborek, J. et al. 1972. Fouling—The major unresolved problem in heat transfer. *Chemical Engineering Progress* (February):59.
- Thrasher, W.H. and D.W. DeWerth. 1994. New hot-water use data for five commercial buildings (RP-600). *ASHRAE Transactions* 100(1):935-947.
- Werden, R.G. and L.G. Spielvogel. 1969. Sizing of service water heating equipment in commercial and institutional buildings, Part I. *ASHRAE Transactions* 75(1):81.
- Werden, R.G. and L.G. Spielvogel. 1969. Sizing of service water heating equipment in commercial and institutional buildings, Part II. *ASHRAE Transactions* 75(II):181.

BIBLIOGRAPHY

- AGA. Comprehensive on commercial and industrial water heating. Catalog No. R-00980. American Gas Association, Cleveland, OH.
- AGA. Sizing and equipment data for specifying swimming pool heaters. Catalog No. R-00995. American Gas Association, Cleveland, OH.
- AGA. 1962. Water heating application in coin operated laundries. Catalog No. C-10540. American Gas Association, Cleveland, OH.
- AGA. 1965. *Gas engineers handbook*. American Gas Association, Cleveland, OH.
- Brooks, F.A. *Use of solar energy for heating water*. Smithsonian Institution, Washington, D.C.
- Carpenter, S.C. and J.P. Kokko. 1988. Estimating hot water use in existing commercial buildings. *ASHRAE Transactions* 94(2):3-12
- Coleman, J.J. 1974. Waste water heat reclamation. *ASHRAE Transactions* 80(2):370.
- EPRI. 1992. *WATSIM 1.0: Detailed water heating simulation model user's manual*. TR-101702. Electric Power Research Institute, Palo Alto, CA.
- EPRI. 1993. *HOTCALC 2.0: Commercial water heating performance simulation tool, Version 2.0*. SW-100210-R1. Electric Power Research Institute, Palo Alto, CA.
- GRI. 1993. *TANK computer program user's manual with diskettes*. GRI-93/0186 *Topical Report* available only to licensees. Gas Research Institute.
- Hebrank, E.F. 1956. Investigation of the performance of automatic storage-type gas and electric domestic water heaters. *Engineering Experiment Bulletin* No. 436. University of Illinois.
- Jones, P.G. 1982. The consumption of hot water in commercial building. *Building Services Engineering, Research and Technology* 3:95-109.
- Olivares, T.C. 1987. Hot water system design for multi-residential buildings. *Report No. 87-239-K*. Ontario Hydro Research Division.
- Schultz, W.W. and V.W. Goldschmidt. 1978. Effect of distribution lines on stand-by loss of service water heater. *ASHRAE Transactions* 84(1):256-265.
- Smith, F.T. 1965. Sizing guide for gas water heaters for in-ground swimming pools. Catalog No. R-00999. American Gas Association, Cleveland, OH.
- Vine, E., R. Diamond, and R. Szydowski. 1987. Domestic hot water consumption in four low income apartment buildings. *Energy* 12(6).
- Wetherington, T.I., Jr. 1975. Heat recovery water heating. *Building Systems Design* (December/January).